

# DOME ENCLOSURES BRACKETS

REVISION 0945



## MAIN FEATURES

Indoor and outdoor installations

## DESCRIPTION

### DBH03

Ceiling bracket for DBH24 dome enclosures. It is designed to provide a cable managed solution.

### DBH04

Wall bracket for DBH24 dome enclosures. It is designed to provide a cable managed solution. Compatible with corner and pole adapters.

### DBH05

Bracket for DBH24 dome installation on parapet and over roofs. It is designed to provide a cable managed solution.

### DPTCH1

Pole adapter compatible with DBH04 brackets.

### DBHWGC

Pole adapter compatible with DBH04 brackets for DBH24 dome installation. Colour RAL9002.

### DCWGH

Corner adapter compatible with DBH04 brackets.



DBH03



DBH04



DBH05



DPTCH1



DBHWGC



DCWGH

AVAILABLE MODELS			
Code	Wall	Ceiling	Parapet
	DBH04	DBH03	DBH05
Dome enclosures			
DBH24	•	•	•
Adapters			
DPTCH1	•		
DBHWGC	•		
DCWGH	•		

## DOME ENCLOSURES BRACKETS

### TECHNICAL DATA

#### GENERAL

Constructed from steel tube (DBH04, DCWGH, DBHWGC)  
 Constructed from aluminium tube (DBH03, DBH05, DPTCH1)  
 Epoxypolyester powder painting, black colour (white for DBHWGC)  
 Enclosure attachment with a single screw (DBH03 and DBH04)

#### MECHANICAL

##### DBH03

Internal cable management  
 Max load: 25kg (55lb)  
 Length: 922mm (36.2in)

##### DBH04

Internal cable management  
 Max load: 25kg (55lb)  
 Length: 357.5mm (14in)

##### DBH05

Installation over parapets  
 Internal cable management  
 Max load: 25kg (55lb)  
 Length: 812.5mm (31.9in)

##### DPTCH1

Pole installation  
 Max load: 50kg (110lb)  
 Pole diameters: 80 - 150mm (3.1 - 5.9in)  
 Compatible with DBH04

##### DBHWGC

Pole installation  
 Max load: 25kg (55lb)  
 Pole diameters 210mm max 225mm (8.2" - 8.85")  
 Colour RAL9002  
 Compatible with DBH04

##### DCWGH

Installation on corners  
 Max load: 50kg (110lb)  
 Compatible with DBH04

#### ENVIRONMENTS

Indoor / Outdoor

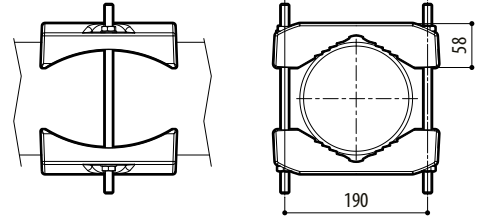
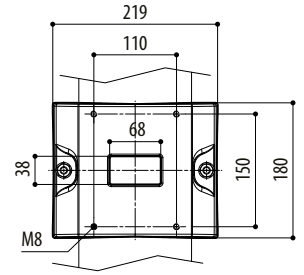

DPTCH1

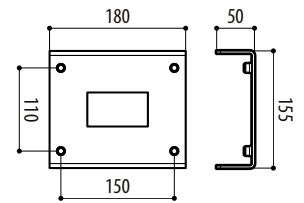

DBHWGC

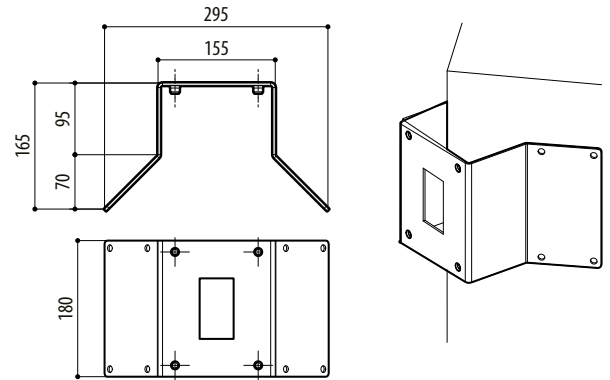

DCWGH

mm 1:10

PACKAGE							
Code	Unit weight		Package weight		Package dimensions (WxHxL)		Master carton
	kg	lb	kg	lb	cm	in	unit
DBH03	2.0	4.4	2.6	5.7	9.0x19.5x105.5	3.5x7.7x41.5	-
DBH04	2.2	4.8	2.6	5.7	16.0x18.5x46.0	6.3x7.3x18.1	8
DBH05	5.0	11.0	6.6	14.5	7.5x51.0x76.0	2.9x20.0x29.9	-
DPTCH1	2.5	5.6	2.8	6.2	20.0x25.5x14.0	7.8x10.0x5.5	10
DCWGH	2.2	4.8	2.7	5.9	24.0x32.0x24.5	9.4x12.6x9.7	6

2 DOME ENCLOSURES BRACKETS

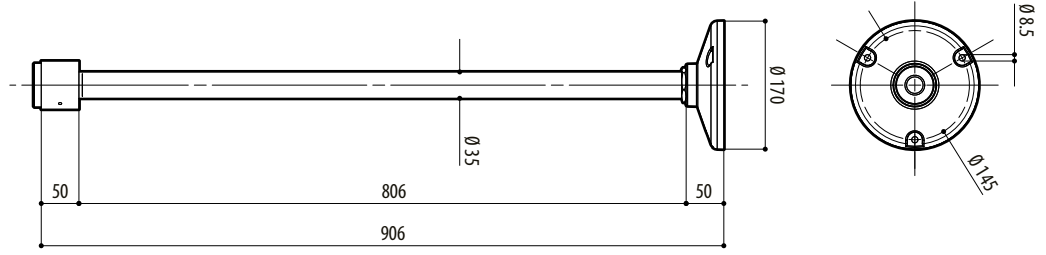

DBH03

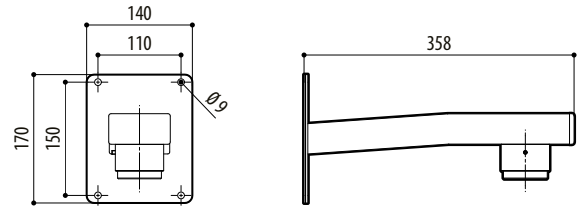

DBH04

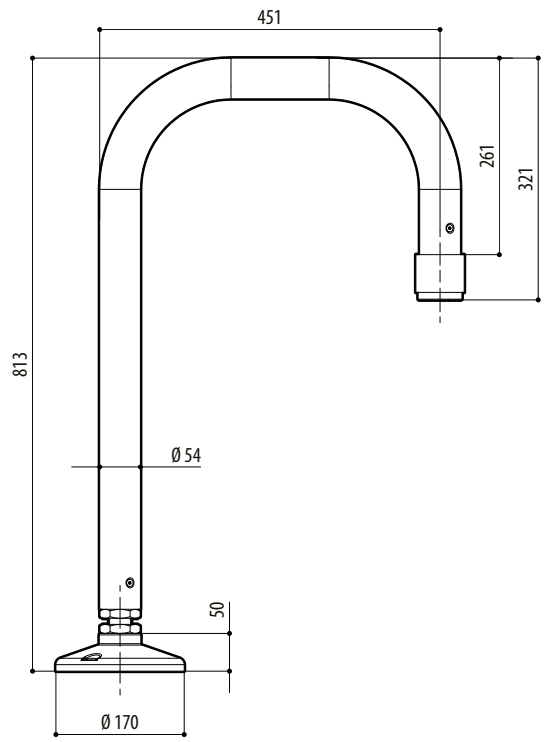

N° 3 HOLES Ø 8.5 AT 120°

DBH05

mm 1:10

## DOME ENCLOSURES BRACKETS