

VANDAL RESISTANT DOOR ENTRY KIT

INCLUDED IN THE KIT

THE DOOR ENTRY PANEL

Choice of stainless steel (BS316) panels from 1 button to 10 button. These flush mounting door entry panel have hinged front plate, terminal strip to simplify the button connections and built in speaker unit. The front plate is secured to the back box with 4 x SRS stainless steel tamper resistant screws. Engraving NOT required.

TELEPHONES

The AN7320 telephones are high quality units with electret microphone and three normally open push buttons (one marked with a key symbol for electric lock release).

POWER SUPPLY (9007)

Voltage output

12v dc (1 Amp)

12v ac (1 Amp)

Voltage input

240v ac (50hz)

Lock release relay

1 - 60 second timer -
changeover relay

Call signal

Tone call or 12v ac buzzer call

ACCESSORIES - NOT INCLUDED IN KIT

Special Engraving

Cable CW1308 (4 pair min)

Lock release 12v ac / dc
Fail locked / open)

Hood (or frame) for Entrypoint
panel

KITS

K4406	6 way
K4407	7 way
K4408	8 way
K4409	9 way
K4410	10 way

NOTE:

Panels come with stainless steel engraved name plates (6 - 10). Alternative numbering can easily be interchanged with the default numbering. Order codes for name plates begin 'NP' eg. a nameplate engraved "15" is stock code "NP15".

ENTRYPPOINT PANEL DIMENSIONS AND ACCESSORIES

No of Buttons	Front plate (H x W)	Back box (H x W x D)	Back box	Hardwood Frame	Flush Hood	Surface Hood
6 - 10	321x181	301x161x50	1007	3503/50	3506/00	3506/50

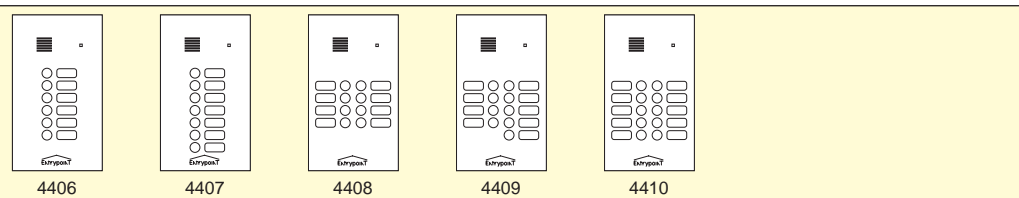

4403

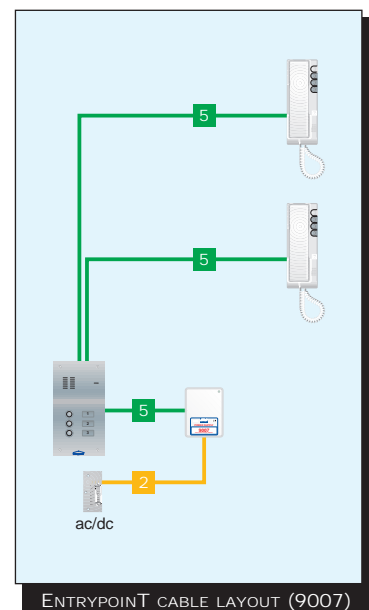

ENTRYPPOINT CABLE LAYOUT (9007)

Cable requirements :

Make connections as per diagram in order to avoid interference.

If the length of the cable from the 9007 terminal C (the call common) is to exceed 10m then this wire should not be run in the same sheath as any audio wires (connections 1 & 2). This is to avoid a low audio tone being heard at the handset.

Ref	Wire Function	Distance (m)			
		50	100	200	300
1	Loudspeaker	0.3	0.5	0.8	1.6
2	Microphone	0.3	0.5	0.8	1.6
6	Common -ve	0.5	0.8	1.0	1.6
9	Lock release	0.5	0.8	1.0	1.6
11	Call buzzer	0.3	0.5	0.8	1.6

Cross sectional area of conductors mm²

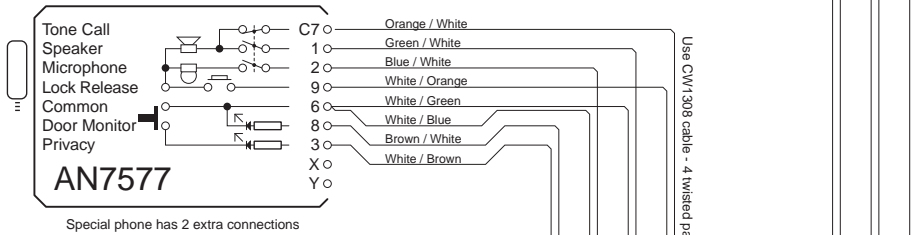
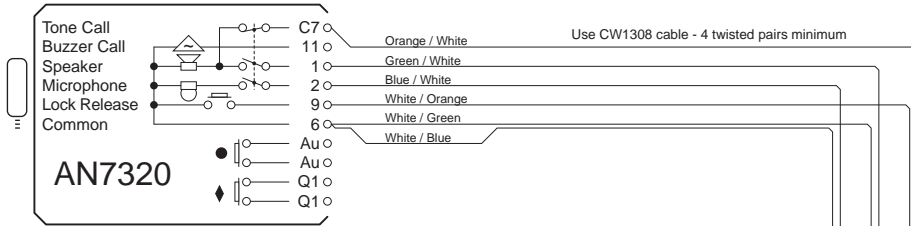

Special phone has 2 extra connections

Telephone Cross Reference

Function	AN0002	AN7320	AN1000	AN7577	70051	70055
Tone Call	C7	C7	C7	C7	11	11
Buzzer Call	11	11	11			
Speaker	1	1	1	1	1	1
Microphone	2	2	2	2	2	2
Lock Release	9	9	9	9	9	9
Common	6	6	6	6	6	6
Privacy LED	3	3	3	3	3	3
Door Monitor	8	8	8	8	8	8
Switch 1	Au	Au	Au			
Switch 1	Au	Au	Au			
Switch 2		Q1				
Switch 2		Q1				

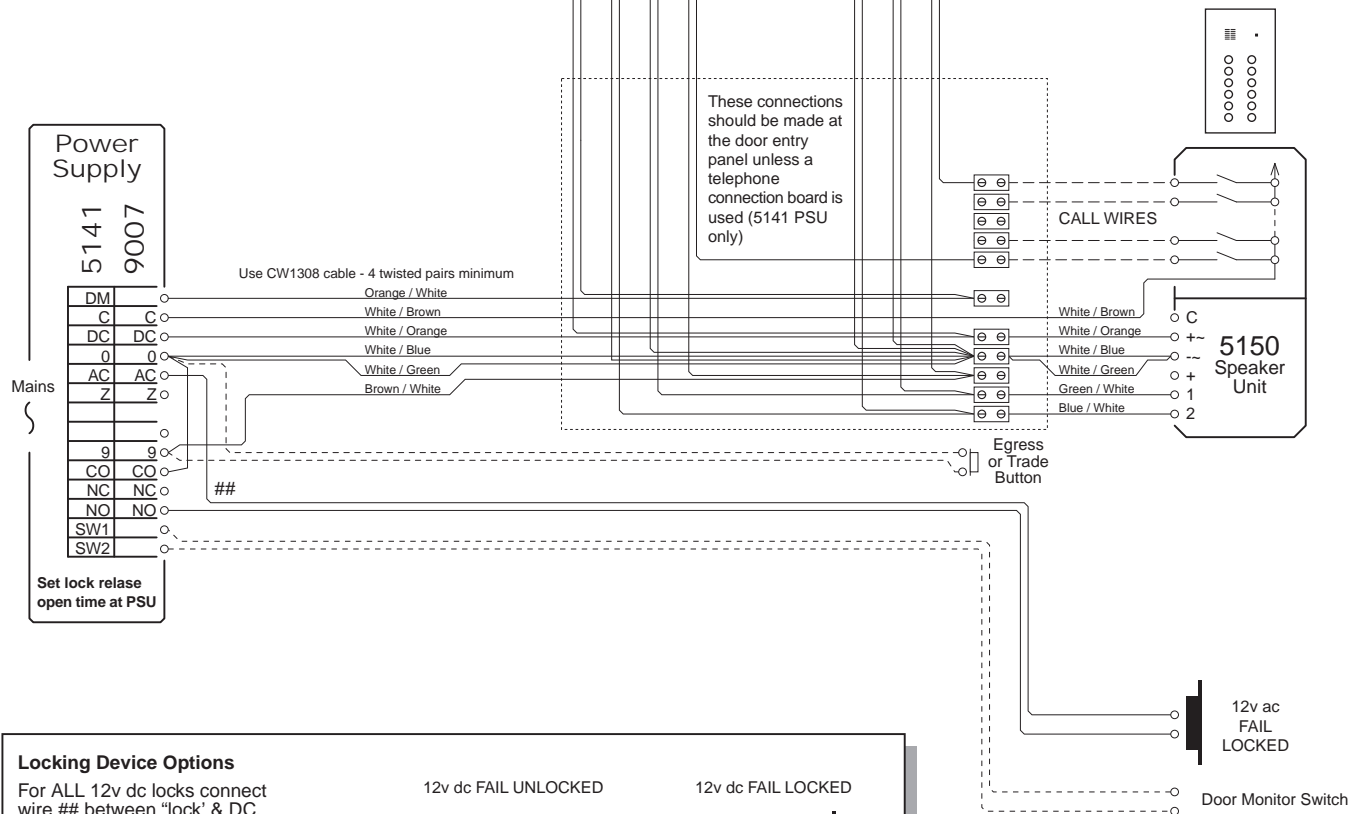

Locking Device Options

For ALL 12v dc locks connect wire ## between 'lock' & DC.

12v dc FAIL UNLOCKED

12v dc FAIL LOCKED

For FAIL LOCKED use NO
For FAIL UNLOCKED use NC

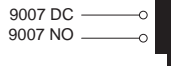
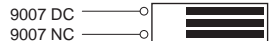

ALWAYS FIT A LOCK SUPPRESSOR