



## Dome Network camera featuring 30x zoom and *Super Dynamic III*

### Key Features





- **Super Dynamic III** technology delivers 128x wider dynamic range compared to conventional cameras.
- High sensitivity with Day-Night function: 0.5 lux (Color) at F1.4 (WIDE), 0.04 lux (B/W) at F1.4 (WIDE). IR cut filter switches on and off to ensure optimal picture quality in both color and B/W.
- Adaptive Digital Noise Reduction: 2D-DNR and 3D-DNR integration ensures reduced noise and motion blur in various conditions.
- Electronic sensitivity enhancement: Auto (Up to 32x) / OFF
- 30x zoom lens: 3.8 mm ~ 114 mm (approx. 300x with digital zoom)
- Pan/Tilt speed of max. 400°/s at preset mode and 0.065°/s super fine control at manual mode
- 5 degrees upper view for various applications
- Auto tracking: The camera automatically pans and tilts to follow a moving subject and keep it in the center of the image.
- Built-in Video Motion Detector with 4 programmable detection areas and 6 sensitivity levels
- Scene Change Detection alarms when lens is covered, spray painted, removed or defocused.
- Various I/O terminals: ALARM IN 1 / BW IN, ALARM IN 2 / ALARM OUT, ALARM IN 3 / AUX OUT
- Alarm sources include Terminal 1 ~ 3, VMD and Panasonic alarm command. Alarm actions include Preset positions 1 ~ 256, PATROL 1 ~ 4, SD memory recording, FTP image transfer, E-mail notification, Indication on browser, Terminal output, Panasonic protocol output and Auto track.
- Auto image stabilizer for applications where vibration or wind is a concern
- Camera title display: 16 alphanumeric OSD and 20 alphanumeric on the browser
- Digital Slip-ring Transmission: The high speed digital video signal supplied by the **Super Dynamic III** DSP travels through the compact slip-ring without any DA/AD conversion process preventing image quality loss.
- Built-in MPEG-4/JPEG digital signal output at VGA image size with up to 30 ips
- MPEG-4 and JPEG dual stream output for simultaneous live monitoring and high resolution recording
- Progressive output with motion adaptive interlace/progressive conversion allows every image to be clear even when the object is moving.
- PTZ control can be made on the user-friendly GUI with 16 speeds pan/tilt and new "Drag and Zoom" operation enabling finer control. 256 speeds available for system with WV-CU950 system controller.
- 360° map shot: 8 thumbnail images at 45° intervals make it simple to direct the camera by clicking on a thumbnail.

- Built-in network interface (10Base-T / 100Base-TX)
- Multiscreen: Image from 16 cameras can be displayed in 4 different Quad screens or 16-screen (JPEG only).
- FTP client function enables periodic image data transfer or transfer upon alarm.
- Alarm notification via e-mail
- Max bit rate/client (64 / 128 / 256 / 512 / 1,024 / 1,536 / 2,048 / 3,072 / 4,096 kbps) or frame rate priority mode (4,096 kbps / Unlimited) for MPEG-4 and Total bit rate control (64 / 128 / 256 / 512 / 1,024 / 2,048 / 4,096 kbps / Unlimited) allowing flexible network management.
- Full duplex 2-way audio allows interactive communication between camera site and monitoring site.
- Alarm log, Manual REC log, FTP error log saved in the SD memory card is displayed on the browser GUI and can be downloaded to the client PC. Playback or Image data download through the log is also available.
- Multi-language GUI and setup menu: English, French, Italian, Spanish, German, Russian (PAL), English, French (NTSC), (Installation required except for English).
- SD memory card slot for Manual recording, Alarm recording and Backup upon network failure
- Scheduling function for Alarm / VMD / Access permission, Preset position call and Position refresh

### Standard Accessories

- |  |   |
|--|---|
| • Operating Instructions ..... 1 pc.       | The following items are for installation.               |
| • CD-ROM ..... 1 pc.                       | • Decorative Cover ..... 1 pc.                          |
| The IP setup software, the viewer software | • Dust Protection Sheet ..... 1 pc.                     |
| and the network operating instructions     | • 8P Alarm Cable ..... 1 pc.                            |
| (PDF) are included on the CD-ROM.          | • Connector for 24 V AC (only for WV-NS954) ..... 1 pc. |
|  | • RJ-45 junction connector ..... 1 pc.                  |

### Optional Accessories

<p>Ceiling Mount Bracket <b>WV-Q105</b></p> 	<p>Embedded Ceiling Mount Bracket <b>WV-Q116</b></p> 	<p>Pendant Mount Bracket <b>WV-Q117</b></p> 	<p>Wall Mount Bracket <b>WV-Q118</b></p> 	<p>Smoke Dome Cover <b>WV-CS3S</b></p> 
---	--	---	--	--

## Specifications

TV System	NTSC	PAL
<b>Camera</b>	1/4-type interline transfer CCD	
Effective Pixels	768 (H) x 494 (V)	
Scanning Mode	2 : 1 interlace scan (with motion adaptive interlace/progressive conversion)	
Scanning Area	3.59 (H) x 2.70 (V) mm	
Minimum Illumination	Color (30IRE): 0.5 lux (Sens up: OFF), 0.02 lux (Sens up: 32x) at F1.4 B/W (10IRE): 0.04 lux (Sens up: OFF), 0.0013 lux (Sens up: 32x) at F1.4	
White Balance	AWC (2,000 - 10,000 K), ATW1 (2,700 - 6,000 K), ATW2 (2,000 - 6,000 K)	
Light Control	Automatic integration of ALC/ELC	
AGC	ON (LOW, MID, HIGH) / OFF	
Super Dynamic III	ON / OFF (With BLC masking 8 x 6 areas)	
Dynamic Range	52 dB typical (Super Dynamic III: ON, Shutter speed: OFF)	
Electronic Shutter	OFF (1/60), AUTO, 1/100	
Electronic Sensitivity UP	OFF / AUTO (2x / 4x / 6x / 10x / 16x / 32x)	
Digital Noise Reduction	High/Low, 2D/3D adaptive DNR	
Black and White Mode	ON / OFF / Auto (High / Low), Wait time: 10 sec. ~ 5 min.	
Digital Zoom	Up to 10x	
Video Motion Detection	For preset position: 4 programmable detection areas, Sensitivity: 6 steps Non-preset position: Detects entire screen except clock area, Sensitivity: 6 steps	
Privacy Zone	Up to 8 zones, Gray / Mosaic	
Auto Image Stabilizer	ON / OFF	
Camera Title (OSD)	Up to 16 characters (alphanumeric characters, marks)	
Auto Focus	AUTO	
<b>Lens</b>	Focal Length: 3.8 mm ~ 114 mm, 30x Zoom, 300x with 10x digital zoom.	
Zoom Speed	Manual: Approx. 0.065°/s (WIDE - TELE) Preset: Approx. 2 sec. (WIDE - TELE)	
Angular Field of View	H: 1.9° (TELE) ~ 52.0° (WIDE), V: 1.4° (TELE) ~ 40.0° (WIDE)	
Maximum Aperture Ratio	1 : 1.4 (WIDE) ~ 3.7 (TELE)	
Focusing Range	1.5 m ~ ∞	
Aperture Range	F1.4 ~ 22, Close	
<b>Pan and Tilt</b>	Panning Range: 360° endless	
Panning Speed	Manual: Approx. 0.065°/s ~ 120°/s, Up to 256 steps (depending on the controller) Preset: up to approx. 400°/s	
Tilting Range	-5° ~ 185° (upward-level-downward) Tilting angle limit: 0° / -1° / -2° / -3° / -4° / -5°	
Tilting Speed	Manual: Approx. 0.065°/s ~ 120°/s, Up to 256 steps (depending on the controller) Preset: up to approx. 400°/s	
Proportional Pan/Tilt Control	Yes	
Number of Preset Positions	256	
Auto Mode	OFF / preset sequence / auto pan / auto track / patrol	
Auto Track	Standard Auto track	
Patrol	1 / 2 / 3 / 4	
Image Hold	ON / OFF	
Digital Flip	Yes	
PTZ Position Display	ON / OFF	
Preset Position Setting	Preset ID / Auto focus / Dwell time / SDIII / ALC mask area	
Map Shot	360° map shot / preset map shot	
<b>Browser GUI</b>	Camera Control: Pan/Tilt (16 steps), Zoom, Focus, Click centering, Drag zoom, Iris, Preset position call and program, Auto mode.	
Display Mode	Image from 16 cameras can be displayed in 4 different Quad screens or 16-screen (JPEG only).	
Camera Title	Up to 20 alphanumeric characters	
SD Memory Data Download	Images recorded in the SD memory card can be downloaded.	
Clock Display	Time: 12H / 24H, Date: 5 formats on the browser, Summer time (Manual)	
Alarm Control	Reset	
GUI / Setup Menu Language	English, French	English, French, Italian, Spanish, German, Russian (Installation required except for English)
System Log	Alarm log, Manual REC log, FTP error log (SD memory required)	
Supported OS	Microsoft® Windows® XP Professional/Home SP2, Microsoft® Windows Vista The language of the OS must be same as selected GUI language.	
Supported Browser	Microsoft® Internet Explorer® 7.0 Microsoft® Internet Explorer® 6.0 SP2 Microsoft® Internet Explorer® 6.0 SP1 (Only with Windows 2000 Professional SP4)	
<b>Network</b>	Network IF: 10Base-T / 100Base-TX, RJ-45 connector	
Image Resolution	VGA (640 x 480) / QVGA (320 x 240)	
Image Compression	MPEG-4: Image quality: LOW / NORMAL / FINE, Transmission type: UNICAST / MULTICAST JPEG: Image quality: 10 steps, Transmission type: PULL / PUSH MPEG-4 and JPEG dual streaming and JPEG multi-resolution supported.	
Image Refresh Rate	0.1 / 0.2 / 0.33 / 0.5 / 1 / 2 / 3 / 5 / 6 / 10 / 15 / 30 ips (Max rate will be 5 ips-VGA, 10 ips-QVGA when transmitting JPEG and MPEG-4 simultaneously)	
Audio Compression	G.726 (ADPCM) 32 kbps / 16 kbps	
Audio Mode	OFF / Mic input / Audio output / Interactive (Half duplex) / Interactive (full duplex)	
Authentication for Audio	Level 1 only / Level 2 higher / All users	
Total Bit Rate	64 / 128 / 256 / 512 / 1,024 / 2,048 / 4,096 kbps / Unlimited	
Max Bit Rate / Client (MPEG-4)	64 / 128 / 256 / 512 / 1,024 / 1,536 / 2,048 / 3,072 / 4,096 kbps or Frame rate priority (4,096 kbps / Unlimited)	
Supported Protocol	TCP/IP, UDP/IP, HTTP, FTP, SMTP, DHCP, DNS, DDNS, NTP, SNMP, RTP	
FTP Client	Alarm image transfer, Periodic image transfer	
No. of Simultaneous Users	Up to 8 users	
SD Memory Card (Option)	Manual REC / Alarm REC / Backup upon network failure. Compatible SD card: Panasonic 64 MB, 128 MB, 256 MB, 512 MB, 1 GB, 2 GB model. SDHC standard card not supported.	
Alarm E-mail	Yes, Port number assignable.	
User Registration	Up to 16 users	
User/Host Level	3 Levels: Administrator, Camera control, Live only	
Security Measures	User authentication (ID 32 digit, PW 32 digit), Host authentication (IP address)	

TV System	NTSC	PAL
<b>Alarm</b>	3x Terminal inputs, VMD, Command alarm	
Alarm Source	Preset position 1 ~ 256, PATROL 1 ~ 4, SD memory recording, FTP image transfer, e-mail notification, Indication on browser, Terminal output, Panasonic protocol output, Auto track	
Alarm Actions	With SD memory card: 5,000 logs, Without SD memory card: 1,000 logs	
Alarm Log	Alarm / VMD / Access permission, Preset position call, Position refresh	
Schedule	1.0 V [P-P] / 75 Ω, NTSC composite, BNC 1.0 V [P-P] / 75 Ω, PAL composite, BNC	
<b>Input / Output</b>	Monitor Output	
Microphone Input	MIC IN (Applicable microphone; Plug-in power type) Supply voltage: 2.5 V ±0.5 V Input impedance: 3 KΩ ±10%	
Audio Output	AUDIO OUT ø3.5 mm stereo mini jack (monaural output) Line level	
External I/O Terminals	ALARM IN 1 / BW IN, ALARM IN 2 / ALARM OUT, ALARM IN 3 / AUX OUT	
<b>General</b>	Safety / EMC Standard: UL (6500 Edition 2), FCC (Part 15 ClassA), CE (EN60065, EN55022, EN55024, ClassB), C-UL (E60065), DOC (ICES003 ClassA)	
Power Source and Power Consumption	24 V AC 60 Hz, 15 W	WV-NS950: 220 ~ 240 V AC 50 Hz, 16 W WV-NS954: 24 V AC 50 Hz, 15 W
Ambient Operating Temperature/Humidity	-10 °C ~ +50 °C (14 °F ~ 122 °F) 90 % or less (without condensation)	
Dimensions	ø154.5 mm x 233 mm (H) (ø6-1/16" x 9-3/16" (H))	
Weight (approx.)	2.2 kg (4.84 lbs.)	WV-NS950: 2.3 kg (5.06 lbs.) WV-NS954: 2.2 kg (4.84 lbs.)

## Part Names and Functions

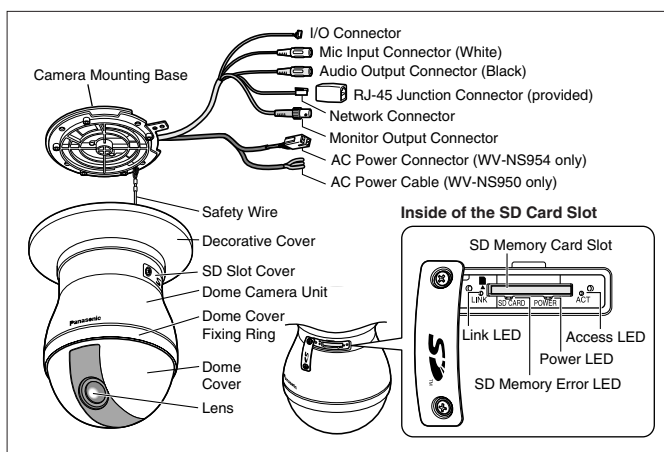

## Appearance

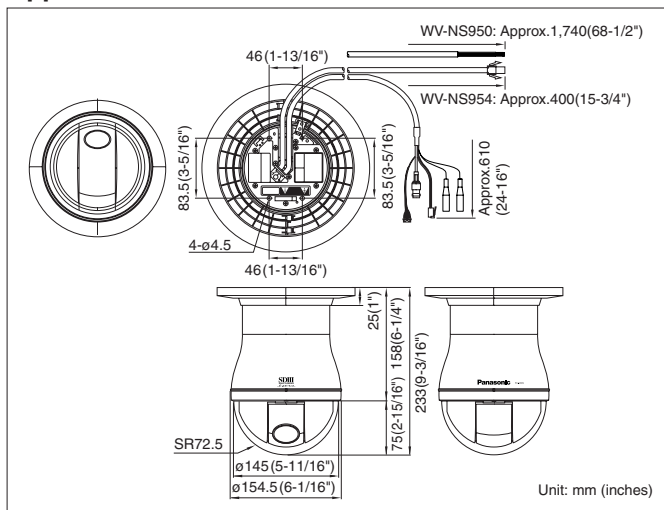

### Trademarks and registered trademarks

– Microsoft, and Windows are registered trademarks of Microsoft Corporation in the U.S. and other countries.

### Important

– Safety Precaution: carefully read the operating instructions and installation manual before using this product.  
– Panasonic can not be responsible for network performance and/or other manufacturer products that reside on the network.

- All TV pictures/menu are simulated.
- Weights and dimensions are approximate.
- Specifications are subject to change without notice.
- These products may be subject to export control regulations.
- Product pictures shown in this catalog are all NTSC models.

DISTRIBUTED BY:

# Panasonic®

<http://panasonic.co.jp/pss/cctv/en/>

Printed in Japan (2A-016AA)