

## AI Motorized Dome Network Camera

NDA A

IP67

Motorized Lens



DATASHEET



### KEY FEATURES

- ▶ NDA A Compliance (The fully NDA A-compliant products are well suited for government, defense and a range of projects subject to the NDA A.)
- ▶ 0.005Lux Starlight (Deliver high detailed color images even in low light environment reaching 0.005Lux.)
- ▶ Advanced Functions (Boasting to support various advanced functions such as HLC, Defog, ROI.)
- ▶ Built-in Microphone (Supporting audio function to hear what is happening in front of the camera.)
- ▶ SIP (Session Initiation Protocol. Providing audio/alarm/intercom and video streaming for mobile phones and video phones.)
- ▶ 3-Axis Mechanical Design (Featuring 3-axis mechanical design for fast and easy adjustment of the camera's viewing angle.)
- ▶ 1TB (Supporting ultra-large external microSD/SDHC/SDXC card storage up to 1TB.)
- ▶ Smart Stream (Bandwidth, storage and bit rate save with Smart Stream ON, eg, H.265+ saves 70%~80% bandwidth of H.264.)

### AI Video Analytics

The AI Camera Series can intelligently filter objects to focus on human and vehicle detection in multiple events such as Region Entrance, Region Exiting, Loitering, Advanced Motion Detection, etc.



### 120dB Super WDR

Sensor-based WDR technology allows the camera to record greater scene details with true color reproduction even under the extreme back light and high contrast conditions. The ratio that the brightest light signal values divided by the darkest light signal values is up to 120dB.

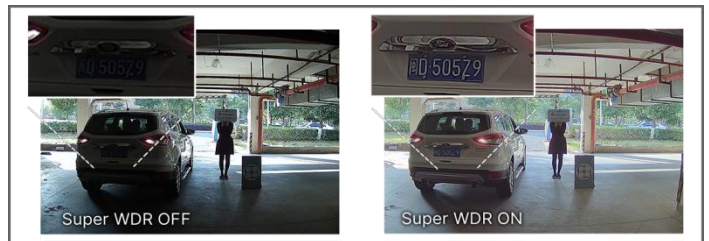

### 0.005Lux Ultra Low-light

The starlight camera is able to deliver high detailed color images even in low light environment reaching 0.005Lux(Color) or 0Lux(B/W), and near infrared light environments without any supplementary lighting.

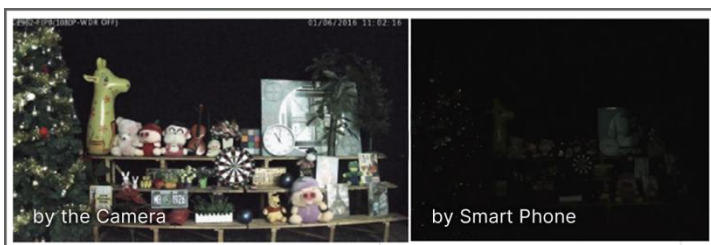

### 4K Video Viewing Experience

The camera performs well in catching detailed image with 4K HD resolution regardless of the moving speed.

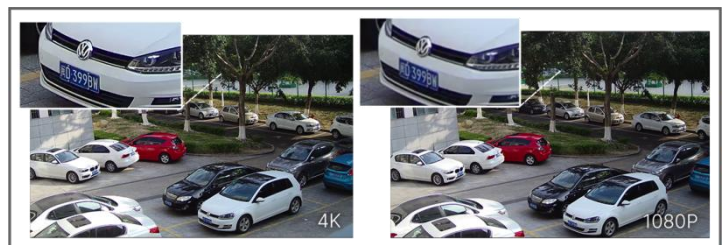

# AI Motorized Dome Network Camera



	Model	MS-C2975-(R)FPD (2MP)	MS-C4575-FPD (4MP)
Camera	Image Sensor	1/2.8" Progressive Scan CMOS	
	Min. Illumination	Color: 0.005Lux@F1.4 B/W: 0Lux with IR on	
	WDR	120dB Super WDR	
	Shutter Time	1/100000s~1s	
	IR Distance	Up to 50m	
	Day/Night Mode	Day/Night/Auto/Customize/Schedule	
	S/N	>55dB	
Lens	Lens	Motorized 2.7~13.5mm/7~22mm@F1.4	
	Field of View	H111°~H34°/D130°~D39°/ V60°~V19°(2.7~13.5mm) H42°~H17°/D48°~D19°/ V24°~V9°(7~22mm)	H97°~H28°/D110°~D32°/ V55°~V16°(2.7~13.5mm) H39°~H16°/D45°~D20°/ V22°~V9°(7~22mm)
	Mount	Φ14	
	Focus Control	Auto/Manual	
Video	Max. Image Resolution	1920x1080	2688x1520
	Primary Stream	60Hz: <b>60fps@(1920x1080)(Optional for R Series)</b> , 30fps@(1920x1080, 1280x960, 1280x720, 704x576) 50Hz: <b>50fps@(1920x1080)(Optional for R Series)</b> , 25fps@(1920x1080, 1280x960, 1280x720, 704x576)	60Hz: 30fps@(2688x1520, 2304x1296, 1920x1080, 1280x720) 50Hz: 25fps@(2688x1520, 2304x1296, 1920x1080, 1280x720)
	Secondary Stream	60Hz: 30fps@(704x576, 640x480, 640x360, 352x288) 50Hz: 25fps@(704x576, 640x480, 640x360, 352x288)	60Hz: 30fps@(1280x720, 704x576, 640x480) 50Hz: 25fps@(1280x720, 704x576, 640x480)
	Tertiary Stream	60Hz: 30fps@(1280x720, 704x576, 640x480, 640x360, 352x288) 50Hz: 25fps@(1280x720, 704x576, 640x480, 640x360, 352x288)	60Hz: 30fps@(1280x720, 704x576, 640x480) 50Hz: 25fps@(1280x720, 704x576, 640x480)
	Video Compression	H.265*/H.265(HEVC)/H.264*/H.264/MJPEG	
	Video Bit Rate	16Kbps~16Mbps(CBR/VBR Adjustable)	
	Privacy Masking	Up to 4 areas	
	ROI	Up to 8 areas	
	Image Setting	Brightness/Contrast/Saturation/Sharpness	
Interface	Ethernet	1*RJ45 10M/100M Ethernet Port	
	Audio I/O	Built-in Microphone; 1/1 (Multi-interface Version)	
	Alarm I/O	1/1 (Multi-interface Version)	

# AI Motorized Dome Network Camera



<b>Network</b>	Network Storage	NAS(Support NFS, SMB/CIFS), ANR	
	Protocol	IPv4/IPv6, ARP, TCP, UDP, RTCP, RTP, RTSP, RTMP, HTTP, HTTPS, DNS, DDNS, DHCP, FTP, NTP, SMTP, SNMP, UPnP, Bonjour, SIP, PPPoE, VLAN, 802.1x, QoS, IGMP, ICMP, SSL,TLS 1.2	
<b>Audio</b>	Audio Compression	G.711/AAC/G.722/G.726	
	Audio Sampling Rate	8/16/32/48KHz	
	Audio Bit Rate	16~256kbps	
	Two-way Audio	Support	
<b>Intelligent Analytics</b>	Video Analysis	Region Entrance, Region Exiting, Advanced Motion Detection, Tamper Detection, Line Crossing, Loitering, Object Left, Object Removed	
<b>System</b>	Storage	Support microSD/SDHC/SDXC Card Local Storage, up to 1TB	
	Advanced Function	BLC, HLC, 2D DNR, 3D DNR, Defog, AWB, IP Address Filtering, AGC, Anti-flicker, Corridor Mode, Deblur	
	SIP/VoIP Support	Yes, Voice & Video-over-IP	
	Event Trigger	Motion Detection, Network Disconnection, External Input, Audio Alarm, etc.	
	Event Action	FTP Upload, SMTP Upload, SD Card Record, External Output, SIP Phone, HTTP Notification, etc.	
	System Compatibility	ONVIF Profile G & S & T, API	
<b>General</b>	Working Temperature	-40°C~60°C	
	Working Humidity	0~90%(Non-condensing)	
	Power Supply	PoE (802.3af); PoE (802.3af) / DC 12V±10% (Multi-interface Version)	
	Power Consumption	5.2W MAX 6.4W MAX (With IR on)	5.5W MAX 6.5W MAX (With IR on)
	Housing	Vandal-proof IK10-rated Metal Housing / Up to IP67-rated for Weather-resistant Performance	
	Weight	780g	
	Dimensions	Φ130mmX115mm	
	Warranty	3/5 Years	

# AI Motorized Dome Network Camera



	Model	MS-C5375-FPD (5MP)	MS-C8175-(S)FPD (4K)
<b>Camera</b>	Image Sensor	1/2.8" Progressive Scan CMOS	
	Min. Illumination	Color: 0.008Lux@F1.4 B/W: 0Lux with IR on	Color: 0.012Lux@F1.4 B/W: 0Lux with IR on
	WDR	120dB Super WDR	
	Shutter Time	1/100000s~1s	
	IR Distance	Up to 50m	
	Day/Night Mode	Day/Night/Auto/Customize/Schedule	
	S/N	>55dB	
<b>Lens</b>	Lens	Motorized 2.7~13.5mm/7~22mm@F1.4	
	Field of View	H99°~H31°/D124°~D38°/ V72°~V23°(2.7~13.5mm) H37°~H15°/D46°~D19°/ V28°~V11°(7~22mm)	H107°~H33°/D125°~D37° /V58°~V18°
	Mount	Φ14	
	Focus Control	Auto/Manual	
	Iris Control	-	
<b>Video</b>	Max. Image Resolution	2592x1944	3840x2160
	Primary Stream	60Hz: 30fps@(2592x1944, 2048x1536, 1920x1080, 1280x960, 1280x720, 704x576) 50Hz: 25fps@(2592x1944, 2048x1536, 1920x1080, 1280x960, 1280x720, 704x576)	60Hz/50Hz: 30fps@(3840x2160, 3072x2048, 2592x1944, 2592x1520, 2048x1536, 1920x1080, 1280x960, 1280x720, 704x576), 20fps(3840x2160)(Optional for S Series)
	Secondary Stream	60Hz: 30fps@(704x576, 640x480, 640x360, 352x288) 50Hz: 25fps@(704x576, 640x480, 640x360, 352x288)	
	Tertiary Stream	60Hz: 30fps@(1280x720, 704x576, 640x480, 640x360, 352x288) 50Hz: 25fps@(1280x720, 704x576, 640x480, 640x360, 352x288)	
	Video Compression	H.265+/H.265(HEVC)/H.264+/H.264/MJPEG	
	Video Bit Rate	16Kbps~16Mbps(CBR/VBR Adjustable)	
	Privacy Masking	Up to 4 areas	
	ROI	Up to 8 areas	
	Image Setting	Brightness/Contrast/Saturation/Sharpness	
<b>Interface</b>	Ethernet	1*RJ45 10M/100M Ethernet Port	
	Audio I/O	Built-in Microphone; 1/1 (Multi-interface Version)	
	Alarm I/O	1/1 (Multi-interface Version)	

# AI Motorized Dome Network Camera



<b>Network</b>	Network Storage	NAS(Support NFS, SMB/CIFS), ANR
	Protocol	IPv4/IPv6, ARP, TCP, UDP, RTCP, RTP, RTSP, RTMP, HTTP, HTTPS, DNS, DDNS, DHCP, FTP, NTP, SMTP, SNMP, UPnP, Bonjour, SIP, PPPoE, VLAN, 802.1x, QoS, IGMP, ICMP, SSL, TLS 1.2
<b>Audio</b>	Audio Compression	G.711/AAC/G.722/G.726
	Audio Sampling Rate	8/16/32/48KHz
	Audio Bit Rate	16~256kbps
	Two-way Audio	Support
<b>Intelligent Analytics</b>	Video Analysis	Region Entrance, Region Exiting, Advanced Motion Detection, Tamper Detection, Line Crossing, Loitering, Object Left, Object Removed
<b>System</b>	Storage	Support microSD/SDHC/SDXC Card Local Storage, up to 1TB
	Advanced Function	BLC, HLC, 2D DNR, 3D DNR, Defog, AWB, IP Address Filtering, AGC, Anti-flicker, Corridor Mode, Deblur
	SIP/VoIP Support	Yes, Voice & Video-over-IP
	Event Trigger	Motion Detection, Network Disconnection, External Input, Audio Alarm, etc.
	Event Action	FTP Upload, SMTP Upload, SD Card Record, External Output, SIP Phone, HTTP Notification, etc.
	System Compatibility	ONVIF Profile G & S & T, API
<b>General</b>	Working Temperature	-40°C~60°C
	Working Humidity	0~90%(Non-condensing)
	Power Supply	PoE (802.3af); PoE (802.3af) / DC 12V±10% (Multi-interface Version)
	Power Consumption	5.5W MAX 6.5W MAX (With IR on)      7.4W MAX 8.4W MAX (With IR on)
	Housing	Vandal-proof IK10-rated Metal Housing / Up to IP67-rated for Weather-resistant Performance
	Weight	780g
	Dimensions	Φ130mmX115mm
	Warranty	3/5 Years



## Structure Diagrams

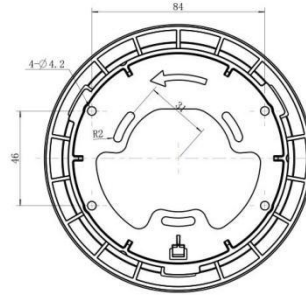
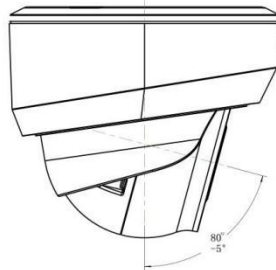
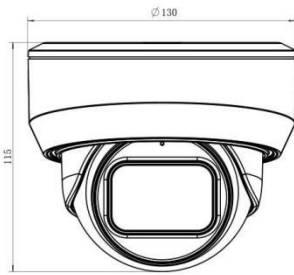
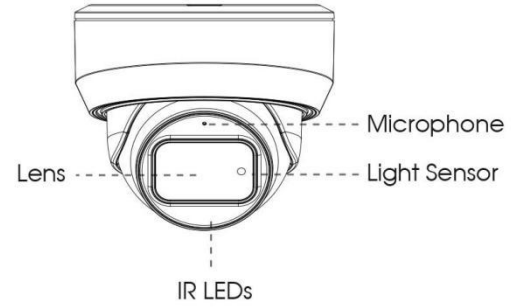
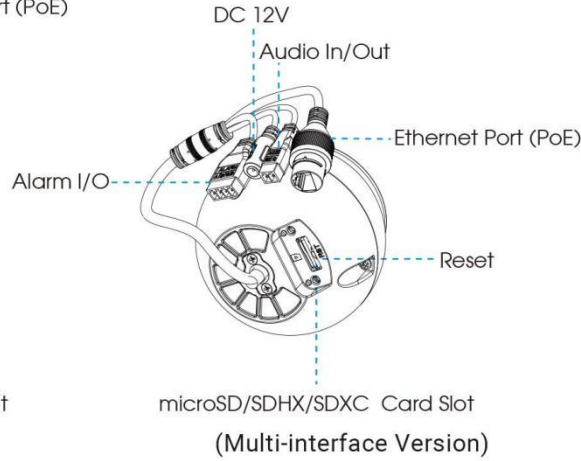
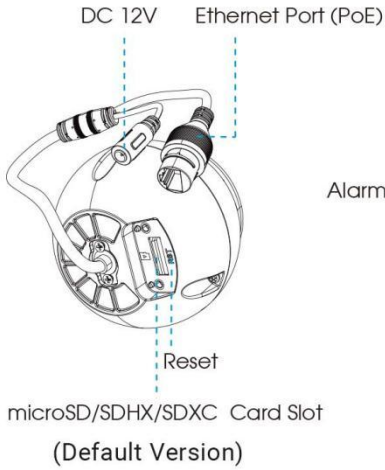

Units: mm

## Accessories Support

A01 Pole Mount

Weight: 720g  
Dimensions: 170\*51.5\*152.6mm



A03 External Corner Bracket

Weight: 900g  
Dimensions: 170\*152.5\*76.3mm



A71 Wall Mount

Weight: 530g  
Dimensions: 162\*124\*78 mm

