

# Entrance & Exit Supplement Light AI LPR Pro Bullet Plus Camera

Supplement Light

Motorized Lens



[DATASHEET](#)

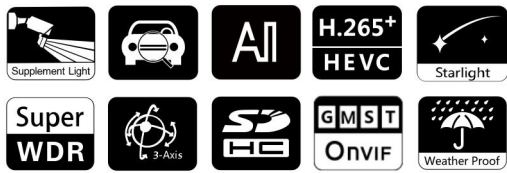

## KEY FEATURES

- ▶ Superior Image Quality (Starlight Sensor, Smart IR II Technology and high frame rate are supported for an excellent image quality.)
- ▶ Evidence Camera Linkage (Link with any regular cameras to capture the overview snapshots as evidence.)
- ▶ LPR Smart Search (Relevant videos can be found quickly by searching for only a portion of the target suspect vehicle's features, such as vehicle type & color, plate color, plate number, direction and etc.,)

## Intelligent AI-powered LPR Algorithm

Entrance & Exit AI LPR Camera can not only recognize vehicle plates in real time, but also identify more vehicle features, like vehicle type, color, etc., generating reliable traffic insights to improve safety and mobility.



## Black and White List and No-plate Event

Entrance & Exit AI LPR Camera enable to achieve stand-alone solutions for license plate recognition as well as no-plate vehicle detection. Alarm is triggered as soon as the corresponding rule-compliant license plate is detected, enabling efficient and accurate access control at any gate.

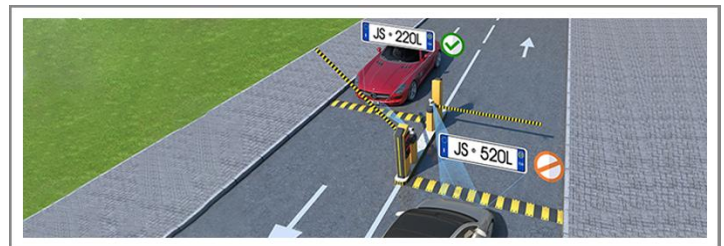

## Extensive Compatibility

Entrance & Exit Supplement Light AI LPR Camera support Wiegand Protocol, which allows the easy open integration with third-party VMS or platforms, realizing solutions such as traffic management, toll collection, and access control.

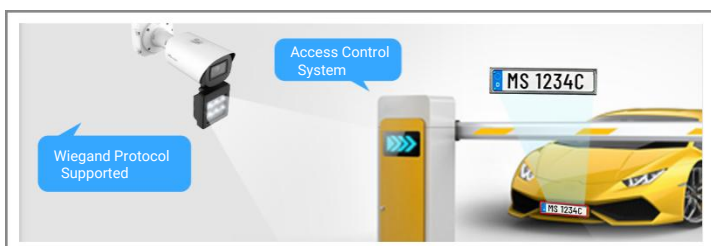

## Integrated Supplement Light

Integrated with supplement light of IR LED Light or White LED Light, Entrance & Exit Supplement Light AI LPR Camera could turn on and off the supplement light, and change the luminance of the supplement lighting automatically, achieving a flexible way for the monitoring control.



# Entrance & Exit Supplement Light AI LPR Pro Bullet Plus Camera



	Model	MS-C2966-RFLWPE	MS-C2966-RFLWPE
		/W (2MP)	/R (2MP)
Camera	Image Sensor	1/2.8" Progressive Scan CMOS	
	Min. Illumination	Color: 0.005Lux@F1.4 B/W: 0Lux with IR on	
	WDR	140dB Super WDR	
	Shutter Time	1/100000s~1s	
	Day/Night Mode	Day/Night/Auto/Customize/Schedule	
	S/N	>55dB	
Lens	Lens	Motorized 2.7~13.5mm@F1.4	
	Field of View	H113°~H33°/D130°~D38°/V60°~V18°	
	Mount	Φ14	
	Focus Control	Auto/Manual	
Entrance & Exit Management	Max. Vehicle Speed	120km/h	
	Recognition Accuracy	>98%	
	Coverage	2 lanes	
	Country/Region Supported	More than 80 countries and regions	
	ANPR Distance	Up to 25m during the day; Up to 25m during the night with illumination	
	Attributes Identification	Plate Color, Vehicle Type, Vehicle Color, Vehicle Brand, No-plate Vehicle Capture, Vehicle Direction Detection	
	Smart Traffic Function	Evidence Camera Linkage	
	White/Black List	Up to 20,000 records inside the camera	
Illuminator	LPR Smart Search	Support	
	Supplement Light	White LED Light	IR LED Light
	Light Bead	6 (For White LED Light)	9 (For IR LED Light)
	Illumination Distance	Up to 65m	
Interface	Light Control	Auto/Always On/Off/Customize	
	Ethernet	1*RJ45 10M/100M Ethernet Port	
	Audio I/O	1/1	
	Alarm I/O	1/1	
	Wiegand	Standard Wiegand 26-bit	
Video	RS485	Support	
	Max. Image Resolution	1920x1080	
	Primary Stream	60Hz: 60fps@(1920x1080, 1280x960, 1280x720, 704x576) 50Hz: 50fps@(1920x1080, 1280x960, 1280x720, 704x576)	

# Entrance & Exit Supplement Light AI LPR Pro Bullet Plus Camera



<b>Video</b>	Secondary Stream	60Hz: 60fps@(704x576, 640x480, 640x360, 352x288, 320x240) 50Hz: 50fps@(704x576, 640x480, 640x360, 352x288, 320x240)	
	Tertiary Stream	60Hz: 30fps@(1920x1080, 1280x720, 704x576, 640x480, 640x360, 320x240) 50Hz: 25fps@(1920x1080, 1280x720, 704x576, 640x480, 640x360, 320x240)	
	Video Compression	H.265*/H.265(HEVC)/H.264*/H.264/MJPEG	
	Video Bit Rate	16Kbps~16Mbps(CBR/VBR Adjustable)	
	Privacy Masking	Up to 8 Areas (Mask Area and Mosaic Area are optional)	
	ROI	Up to 8 areas	
	Image Setting	Brightness/Contrast/Saturation/Sharpness	
<b>Network</b>	Network Storage	NAS(Support NFS, SMB/CIFS), ANR	
	Protocol	IPv4/IPv6, ARP, TCP, UDP, RTCP, RTP, RTSP, RTMP, HTTP, HTTPS, DNS, DDNS, DHCP, FTP, NTP, SMTP, SNMP, UPnP, Bonjour, SIP, PPPoE, VLAN, 802.1x, QoS, IGMP, ICMP, SSL	
<b>Audio</b>	Audio Compression	G.711/AAC/G.722/G.726	
	Audio Sampling Rate	8/16/32/44.1/48KHz	
	Audio Bit Rate	16~256kbps	
	Two-way Audio	Support	
<b>System</b>	System Compatibility	API, HTTP, TCP, Wiegand Protocol, ONVIF Profile G & M & S & T	
	Storage	microSD/SDHC/SDXC Card Local Storage, up to 1TB	
	Advanced Function	BLC, HLC, 2D DNR, 3D DNR, Defog, AWB, IP Address Filtering, AGC, Anti-flicker, Corridor Mode, Deblur, Watermark	
	SIP/VoIP Support	Yes, Voice & Video-over-IP	
	Event Trigger	Black/White List, Motion Detection, Network Disconnection, External Input, Audio Alarm, etc.	
	Event Action	FTP Upload, SMTP Upload, SD Card Record, External Output, SIP Phone, HTTP Notification, etc.	
<b>General</b>	Working Temperature	-40°C~60°C	
	Working Humidity	0~95%(Non-condensing)	
	Power Supply	PoE (802.3at) / DC 12V±10%	
	Power Consumption	6W MAX 24W MAX (For White LED Light)	6W MAX 24W MAX (For IR LED Light)
	Weather Proof	Up to IP67-rated for Weather-resistant Performance	
	Surge Protection	4KV	
	Weight	1630g 2075g (With Supplement Light)	
	Dimensions	320mmX134mmX126mm 320mmX134mmX231mm (With Supplement Light)	
	Warranty	3/5 Years	



## Structure Diagrams

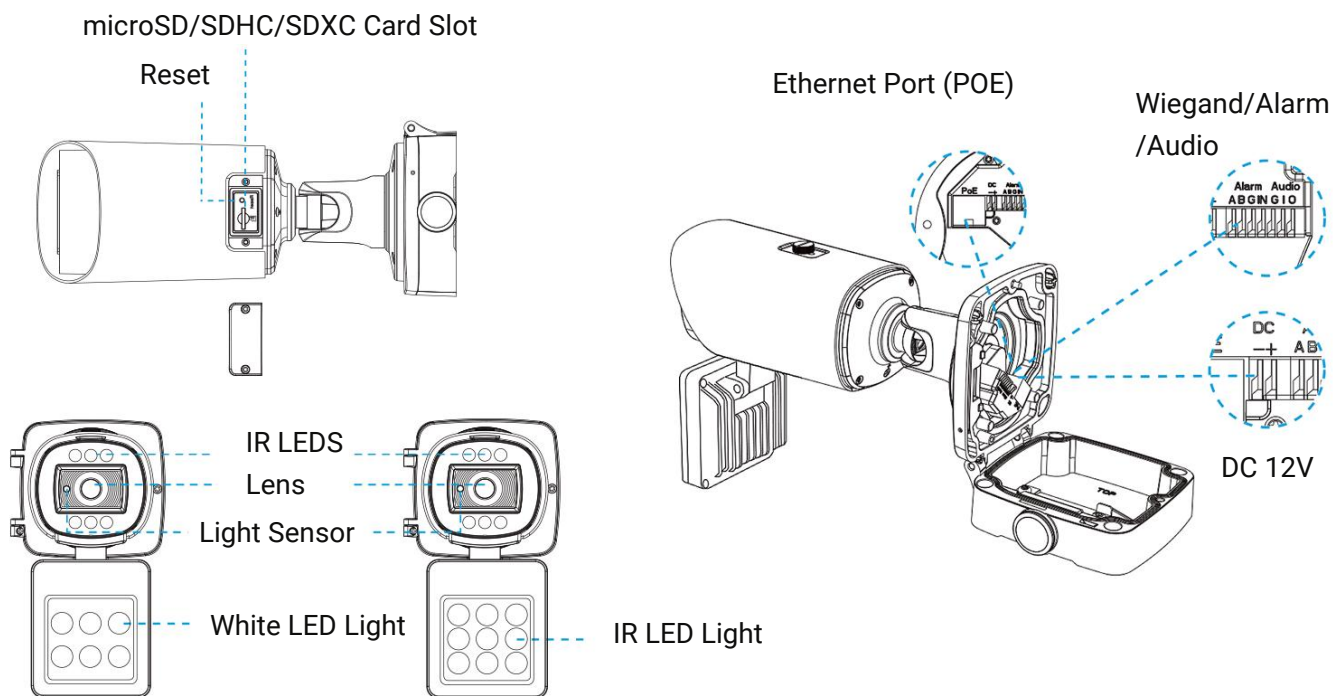

**Note:** Switching to web side to use Wiegand and Alarm Output.

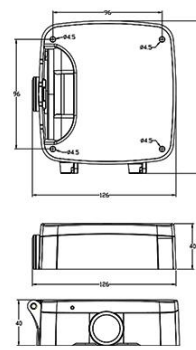
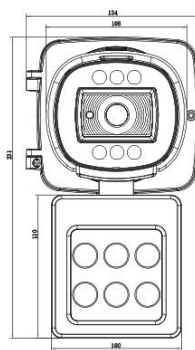
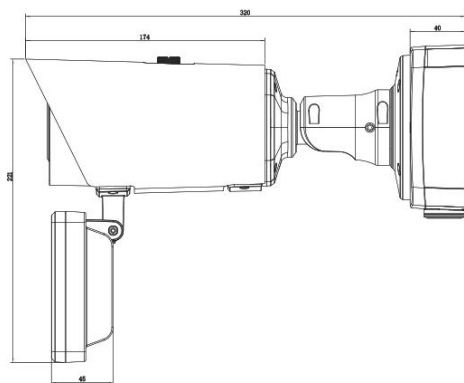

Units: mm

## Accessories Support

### A62 Junction Box(Default)

Weight: 510g

Dimensions: 134\*126\*40mm



### A01 Pole Mount

Weight: 720g

Dimensions: 170\*51.5\*152.6mm



### A03 External Corner Bracket

Weight: 900g

Dimensions: 170\*152.5\*76.3mm

