

EL2 IR Bullet

Compact 2MP IR bullet, designed for outdoor and indoor installations



ONVIF | SGT

For customers who need a cost-effective compact camera, the **EL2 IR Bullet** from March Networks® integrates active IR illumination, and 2MP resolution to deliver high-quality images in a variety of lighting conditions. This essential camera is rated for indoor and outdoor use with a housing designed to be weather-proof (IP66 and IP67) and vandal-resistant (IK10).

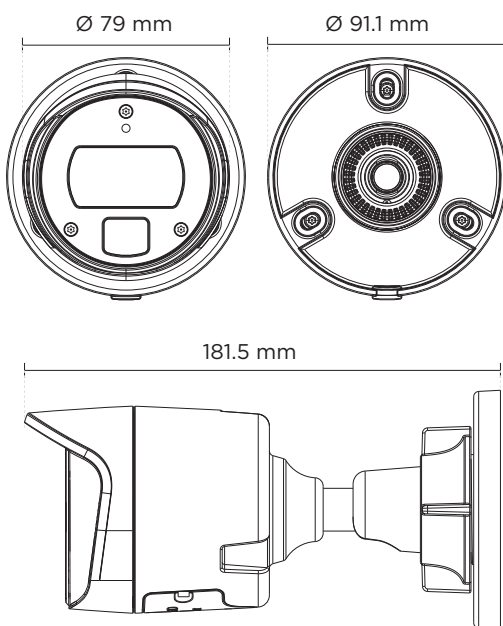

Key Benefits

- ▼ **Smart Motion Detection.** Eliminate false alarms and reduce unnecessary recording with Smart Motion Detection, a feature that enables the camera to send an alert when a person or vehicle is detected.
- ▼ **Rugged housing.** The IK10, vandal-resistant design withstands impact on the body of the housing, and the IP66 and IP67 ratings protect the camera from dust and water intrusion.
- ▼ **Smart IR Illumination.** The built-in LED provides uniform illumination in a variety of lighting conditions, which means users will see high-quality, low-noise video from 100 feet away. Additionally, the camera automatically adjusts the intensity of the IR LED to compensate for the distance of an object, so the object is not overexposed when it gets too close to the camera.
- ▼ **Never worry about losing video again.** Our cameras can record to internal microSDHC cards or NAS devices, giving you redundant recording in the event of a network outage or power failure.

A cost-effective camera that delivers high-quality images in a variety of lighting and weather conditions.

EL2 IR Bullet

CAMERA

Image Sensor	1/3" Progressive Scan CMOS
Effective Pixels	2MP; 1920 (H) x 1080 (V)
Lens	2.8mm, F2.0, fixed focal 3.6mm, F2.2, fixed focal
Field of View	2.8mm: Horizontal: 118° 3.6mm: Horizontal: 90°
High Dynamic Range (HDR)	69dB
Day/Night	Automatic IR cut filter
Minimum Illumination	2.8mm: Color: 0.08 lux; B/W: 0.05 lux; 0 lux with IR On 3.6mm: Color: 0.1 lux; B/W: 0.05 lux; 0 lux with IR On
Shutter Speed	1/5s to 1/32000s
Camera Angle Adjustment	Pan 340°, Tilt 80°, Rotation -100° to 100°
Pan/Tilt/Zoom	Digital PTZ via Command
White Balance	Manual/Automatic
IR Wavelength	850nm
IR Illumination Distance	98 feet (30m)

VIDEO

Video Compression	H.265, H.264, M-JPEG
Resolution	2MP 1080p (1920x1080), 1MP 720p (1280x720), WXGA (1360x768)
Frame Rate	Up to 30fps @ 2MP
Streaming	Up to 2 individually configurable streams in H.265/H.264/M-JPEG Configurable resolution/frame rate/bandwidth
Dual Streams	H.2MP 1080p (1920x1080) @ 30fps + H.1MP 720p (1280x720) @ 30fps
Image Settings	Backlight compensation, white balance, noise reduction, wide dynamic range, privacy mask, brightness, exposure, sharpness, contrast, saturation, smart IR, day/night threshold

NETWORK

Security	Password protection, HTTPS encryption (configuration only), IEEE 802.1X
Supported Protocols	IPv4/v6, TCP/IP, UDP, RTP, RTSP, HTTP, HTTPS, DHCP, PPPoE, QoS, ONVIF-S/G/T, SNMPv1/v2/v3

SYSTEM INTEGRATION

Video Analytics	Smart motion detection
Alarm Trigger	Video analytics
Alarm Events	Video recording to local storage

ELECTRICAL

Power	PoE (802.3af, Class 0); 12VDC
Power Consumption	PoE: typical 4W, max 6.5W; 12VDC: typical 3.4W, max 5.1W

PHYSICAL

Construction	Aluminum housing and polycarbonate window
Dimensions	3.6 x 7.2 in (91.1 mm x 181.5 mm)
Weight	1.48 lb (0.67 kg)

ENVIRONMENTAL

Operating Temperature	-22° to 122°F (-30° to 50°C)
Humidity	95% RH, non-condensing
Ingress Protection Rating	IP66, IP67
Impact Rating	IK10

USER CONNECTIONS

Ethernet	RJ45 10/100 Base-T
Power	Barrel-type







GENERAL

Local Storage	MicroSD/MicroSDHC/MicroSDXC memory card up to 1TB (sold separately)
LED Indicator	Power, Activity
Included Accessories	Quick Start Guide; mounting template; mounting hardware

REGULATORY

Certification Model	C4301A
Safety	UL 62368-1, CSA 62368-1, IEC/EN 62368-1
Emissions	EN55032/BS EN55032, EN61000-3-2/BS EN61000-3-2, EN61000-3-3/BS EN61000-3-3, FCC part 15 Subpart B, class B, ICES-003, CISPR32, AS/NZS CISPR32
Immunity	EN55024/BS EN55024, EN55035/BS EN55035
Environmental	RoHS2, RoHS3
Compliance Marking	CE, UKCA, cULus, RCM, WEEE, NOM

MOUNTING OPTIONS

 L-Shape Wall Bracket	 4 Inch Mounting Adapter Plate (Octagon and Single Gang Box)	 Outdoor Back Box
 Outdoor Conduit Box	 Pole Mount Adapter	 Corner Mount Adapter

ORDERING INFORMATION

CAMERA	
40559-101	EL2 IR Bullet (2.8mm)
40559-102	EL2 IR Bullet (3.6mm)
ACCESSORIES	
40741	L-Shape Wall Bracket
40742	4 Inch Mounting Adapter Plate (Octagon and Single Gang Box)
40744	Outdoor Back Box
40745	Pole Mount Adapter
40746	Outdoor Conduit Box
40747	Corner Mount Adapter

5-year warranty:

- Option for Advance Replacement or Repair & Return.
- No need to issue a PO prior to receiving the replacement.
- March Networks incurs all shipping costs — both ways — for Advance Replacements.