

Galaxy[®] Flex



Flexible control panel range for small to medium sized security installations

An enhanced, feature-rich Galaxy[®] Flex control panel range is now available from Honeywell. Compliant to EN50131, PD6662:2010 standards this hybrid intruder and door control security solution brings ease and flexibility to small to medium sized, Grade 2 security systems. Expansion costs are minimised thanks to 12 on-board zones which are fully customisable and further expandable due to the modular system design of Galaxy Flex.

Galaxy Flex 20 is feature packed for small systems up to 20 zones, Flex 50 delivers high flexibility for small to mid size systems where ease of install and functionality are important and Flex 100 offers a highly competitive system for a greater number of zones and functionality.

What's new?

Remote access Mobile App

Available to download for both Apple and Android devices, Honeywell's **GX remote control** is a mobile app for the Galaxy^{*} range. Via Honeywell's Ethernet module end users can now access their system remotely, providing them with complete control of the system for status reporting, set/unset, log information and more. GX remote control delivers reliable, flexible security on the go, all at the touch of a button.

Night Set Mode

Galaxy Flex now includes enhanced part set features including night set mode, which provides fast, easy programming of setting requirements for residential applications. This enhanced feature will allow zones to be easily allocated across multiple setting options: full, part and night time. Add to this the renowned Galaxy group option, and the Galaxy Flex offers a fully equipped solution for all residential and commercial installations where hybrid systems are demanded.

Smaller and affordable metal control panel

Flex is available in a new compact metal housing and is ideally suited for those applications where installation space is a challenge. At a very competitive price this entry level control panel provides a powerful Security Grade 2 intruder system packed with features in a small, convenient package.

Flexible communication options including IP

Quick set up wizards improve communications programming, with simple step by step set up of Honeywell Multi-path communications across PSTN, GSM/GPRS or Ethernet. Making the set-up and Alarm Receiving Centre (ARC) connections an easy process, aiding any training requirements whilst saving time on site. Full encryption is available on Ethernet and GPRS and receiver support is available via a range of common receiver solutions across Europe. Using existing communications paths minimises installation costs and intuitive communications programming facilitates an error-free set up. Full diagnostics offers the capability to check on the system's status at any time and the means to test, diagnose and repair it remotely. This reduces time spent on trouble-shooting, maintenance and customer site visits.

All in one box

To meet the ever increasing demands on resources, installers need look no further than Galaxy Flex to optimise installation, programming time and costs. Inside the panel housing are custom moulded fittings that accommodate wireless, communications, expansion and other functionalities via modules that simply click in. Not only is it quick to install, the box is made of a robust flame-retardant polymer material which makes it less likely to be dented or damaged during installation.

No limits wireless

Take the wireless route when aesthetics are important or cabling is impractical or too expensive. Galaxy Flex offers the flexibility of wired and wireless in one robust system without compromising the reliability of the system thanks to Honeywell's proven bi-directional radio and agile routing technologies. This extends the sensor battery life up to 5 years and because the sensors auto-detect, installation is quick and easy.

USB connect

Onsite programming and testing is quick and easy using the on-board USB to connect via laptop to the Remote Servicing Suite (RSS). Programming is quick and easy with Galaxy Flex's intuitive Windows programming interface.

Know one Galaxy, know them all

Because Galaxy Flex is based on the tried and trusted Galaxy[®] platform, it uses the same intuitive menu based programming as Galaxy Dimension. Installers need only learn one platform to meet the needs of the smallest to the largest security installations. Plus with a common range of peripherals, stock as well as training is minimised.

Lower system maintenance costs

Galaxy Flex can be monitored from a central location using Galaxy's Remote Servicing Suite (RSS) software allowing installers to provide customers with instant support and improved service as well as saving their own time and money. Installers can monitor the system remotely with full automatic periodic transmission of diagnostics information so that they have a complete system health status at their fingertips, reducing the number of site visits so that they can focus resources on more lucrative new business opportunities. Whether it is a routine inspection, scheduled maintenance or simply checking the system status, it can be done remotely from a fixed or mobile location.

False alarm reduction using visual verification

Reducing false alarms through reliable confirmation of alarms is becoming a vital element of a security system. In addition to sequential and audio verification, Galaxy Flex offers image sequence verification to confirm alarms. Using the new ISN3010B4 camera PIR and Honeywell PE 1800IP alarm receiver, the Alarm Receiving Centre (ARC) receives a sequence of pre- and post- alarm images to distinguish between real and false alarm signals received. The ARC can then react to a genuine alarm and avoid penalties and costs associated with false alarms. Furthermore, images taken by the camera sensors can be used as proof of an intrusion and by the police to help trace and identify an intruder. Visual verification capability is a cost effective option to help ARCs to discriminate between real and false alarms using linked image sequences which can be triggered from any alarm source on any system zone.

Choose Galaxy Flex and experience the ease and flexibility of Honeywell. Visit www.galaxyflex.com or contact our sales team using the details overleaf.

Galaxy[®] Flex

Features

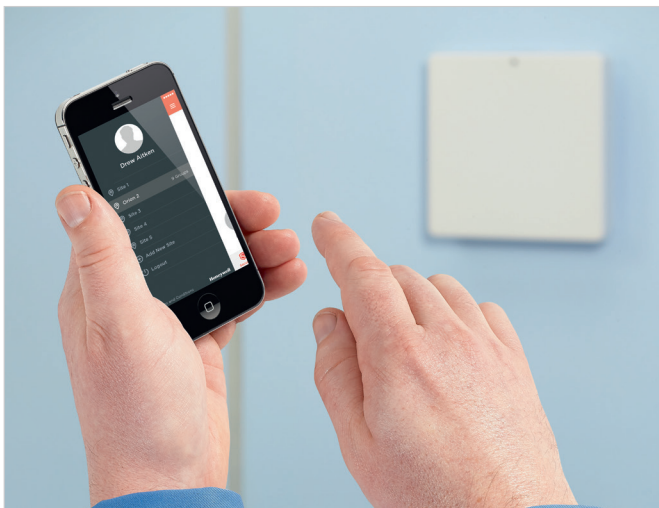
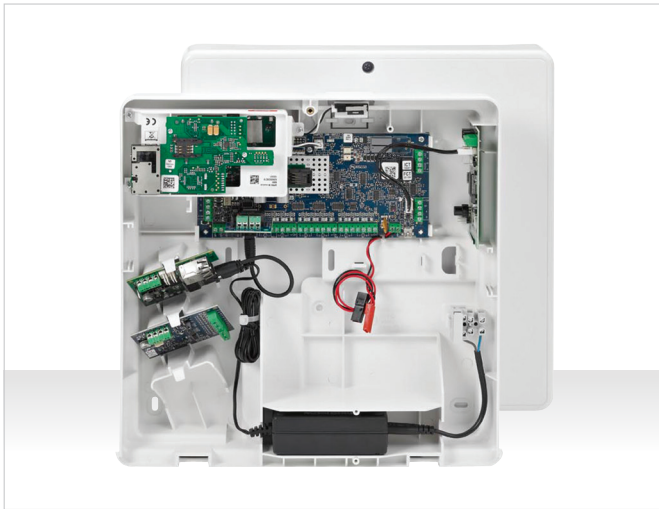

- **Alarm verification by image sequence**

- ISN3010B4 records around 100 images at 640 x 352 pixels
- Up to 35 images per sequence with 10 image pre-alarm memory
- Images received by Honeywell PE alarm receiver

- **Multiple communications options**

GSM/GPRS, Ethernet, PSTN programmable via quick set up wizards

- **Mobile App**

Users can remotely access and manage their Galaxy Flex system, anytime, anywhere using the GX Remote Control Mobile App. Free to download from iTunes or Google Play App stores.

- **Flexible expansion**

- Up to 100 wired or wireless zones
- Up to 98 users
- Up to 98 wireless key fobs
- Protecting up to eight groups

- **Door control**

Up to four door controllers (DCMs) controlling up to eight doors
Access event log records up to 1000 events
Compatible with most Wiegand readers

- **Part set functionality**

Night set mode allows easy configuration for residential applications

- **Up to 4 annual holiday and 4 weekly schedules available**

- **Firmware version V3**

Includes alarm verification with video, delivering improved communications

- **Multiple user interfaces**

MK8 and traditional MK7 keypads/proxes, remote access with GX remote control Mobile App any time, any where

- **Three Box sizes with power options**

Range of boxes to suit different installation needs with 1A or 2A power supplies

- **Resettable fuses (PTCs)**

Integrated resettable fuses for auxiliary power supply and battery

- **Auto-detect function for faster installation**

System automatically recognises when modules are added/removed from system when auto-detect mode is enabled

- **One comprehensive range**

A choice of wired and wireless intrusion and environmental detectors

- **Full compliance**

Tested by a third party to meet EN50131, PD6662:2010, BS8243:2010, Security Grade 2, Environmental Class II standards.
Great variety of zone wiring: Double Balanced, End of Line circuit, choice of Resistance Values and Normally Closed Loop Wiring

Technical Specifications

Description	FX020	FX050	FX100
Zones on board (Wired/Wireless)	12 - 20	12 - 52	12 - 100
Wireless transceiver/RF portal	8	8	8
Outputs—switched (with trigger module)	3-7 (15)	3-23 (31)	3-47 (55)
Trigger outputs—relay	0-1	0-1	0-1
Integrated PSU	1A*	1A*	1A*
Output current rating (EN50131 / Security Grade 2)	0.7	0.7	0.7
Keypads/Keyprox	4	4	8
Bus mounted prox readers	4	8	8
Door controllers (DCM)	2	4	4
DCM controlled doors	4	8	8
Users	23	48	98
Multi-users	4	4	4
7 day timer schedules (Autoset & Access)	2	4	4
Event log	500	500	1000
Access log	500	500	1000
Access control groups (user templates)	5	10	20
Speaker driver	Yes	Yes	Yes
Local communication interface	USB	USB	USB
Groups/Zones	3	4	8
Part set per group	2	2	2
Silent-night set option	Yes	Yes	Yes
Links	5	5	5
RS485 databases	1	1	1
SMS text	Yes	Yes	Yes
Library	Yes	Yes	Yes
Mobile App	Yes	Yes	Yes
Visual Verification*			
Camera PIR capacity	5	5	5
Communication options			
PSTN	onboard	onboard	onboard
Ethernet	optional	optional	optional
GSM/GPRS	optional	optional	optional
Audio options			
2-way voice option	34 speaker channels	34 speaker channels	34 speaker channels
Mechanics			
Dimensions (h x w x d)	-S 255 x 370 x 115mm -M 333 x 337 x 93mm -L 393 x 367 x 98mm		
Weight (excluding battery and in-box peripherals)	-S 3.2kg (metal box)	-M 1.8kg	-L 2kg
Approvals	Suitable for use in systems complying to EN50131-1: 2006 +A1:2009 and tested to EN50131-3: 2009; Security Grade 2; Environmental Class II; PD6662/2010: BS8243:2010		

Notes: * Available on Flex panels with firmware version 3.0 onwards.
 ** 2A panel variant is available - ask your local sales representative for details.
 Honeywell reserves the right to alter the specification of products without notice.
 *** When used with audio interface order code CO84.

Order References

Control Panels

C005-S-E1	Galaxy Flex FX020 Small box, 1A
C005-M-E2	Galaxy Flex FX020 Medium box, 1A
C006-M-E2	Galaxy Flex FX050 Medium box, 1A
C007-M-E2	Galaxy Flex FX100 Medium box, 1A
C005-L-E2	Galaxy Flex FX020 Large box, 2A
C006-L-E2	Galaxy Flex FX050 Large box, 2A
C007-L-E2	Galaxy Flex FX100 Large box, 2A

Panel kits with peripherals

The Flex 20 is also available to buy as part of a kit, offering peripherals at discounted prices.

C005-E2-K01	Medium panel with MK7 Keypad (Dutch version is K05)
C005-E2-K02	Medium panel with MK7 Keyprox (Dutch version is K06)
C005-E2-K03	Medium Panel with MK8 Keypad
C005-E2-K04	Medium Panel with MK8 Keyprox
C005-E2-K11	Large panel with MK7 Keypad
C005-E2-K12	Large panel with MK7 Keyprox
C005-E2-K13	Large panel with MK8 Keypad
C005-E2-K14	Large panel with MK8 Keyprox
C005-E1-K21	Small panel with MK7 Keypad
C005-E1-K22	Small panel with MK7 Keyprox
C005-E1-K24I	Small panel with MK8 keyprox and Ethernet.

Additional modules

The kit part numbers can have one of the following suffixes added to form a customised kit with additional peripherals as required:

G	GSM/GPRS module
I	IP Ethernet/Internet module
R	RF Portal radio module

Mobile App downloads

Search GX Remote control on:
 Google Play <https://play.google.com/store>



iTunes <https://itunes.apple.com>

User Interfaces

CP037-00	MK7 Keypad
CP038-00	MK7 Keyprox
CP050-00-01	MK8 Keypad
CP051-00-01	MK8 Keyprox

Modules

A083-00-01*	Ethernet module
A073-00-01	Direct mount RF portal PCB
C079-2	RF portal in plastic housing
A081-00-01*	GSM/GPRS module
A071-00-02*	Galaxy Flex trigger module
A074-00-01	Output Option Board (Relay Interface)

Alarm Verification by Image Sequence*

ISN3010B4	Camera PIR sensor
PE1800IP	Alarm Receiver

Door Control

C080-00	DCM - Door controller
C081-00	DCM - Door controller with PSU
MX04	MAX4 proximity reader

Remote Servicing

R056-CD-L	Standalone Remote Servicing Suite (RSS)
R057-CD-DG	Remote Servicing Suite with USB dongle & client/server version
R058-CD-DG	User Management Suite (UMS) with USB dongle

Power Supply Units

P025-01-B	Galaxy power unit
P026-01-B	Galaxy power RIO

Audio

CO84	Audio interface module
CO85	Audio MUX Extension
TP 800***	2 Way voice speaker-mic

Flexible control panel range for small to medium sized security installations

Flexible Communications for Alarm Signalling and Remote Servicing

- PSTN built-in plus the option of GSM/GPRS and Ethernet to plug-on
- Full configuration for multi-path back-up of alarm signalling using all available communication channels
- Programming Wizard to simplify setup of alarm signalling

GX remote control - Galaxy Mobile App

- Remotely manage home and premises security systems wherever you are
- One app for all your systems
- Free to download and use
- Simple secure 10 second login
- Single touch interrogation of alarm history
- Manage up to 5 systems from a single smart device
- Single tap switch between property and user specific groups



Smart Device



GSM/GPRS module

Ethernet module



Mini USB connector

Communications options

Alarm Verification by Image Sequence

- Visually confirm alarms without the cost of a CCTV solution
- PIR camera with 100+ picture memory at 640 x 352 pixels and with colour/black and white auto switch in low light and night illumination
- Fast reaction to record alarm images with pre-alarm frames
- Low-bandwidth of video clips mean transmission over GPRS is possible



Camera PIR sensor

Visual verification

Remote Maintenance

- Provides complete remote servicing capability including off-line programming, real-time control and diagnostic reporting
- Programming upload and download
- Event log and access log upload
- Remote Routine Inspection (RRI)
- Mimic panel for control functions
- Online keypad support



Remote Servicing Suite (RSS)
User Management Suite (UMS)

Remote maintenance

Attractive User Interfaces

A range of LCD Keypad and Keyprox options plus mobile app

- Check and control the system from anywhere in the world with the mobile app **GX Remote Control** from your preferred smart device (requires Ethernet module)
- MK8 keypad offers a modern keypad and keyprox design with all the familiarity and functionality of the MK7 keypad
- Familiar keypad for installer programming across the Galaxy range
- Proximity function across all user interfaces allows quick and secure set and unset without PIN code



MK8



MK7

User interfaces

Door control

Proximity Reader - MAX4

- Complete door control in a single unit
- Can be used as standalone or integrated into the Galaxy® control system
- Connected on RS485 bus

Door Control Module (DCM)

- Supports up to 4 door control modules
- Each door control module has 2 Wiegand inputs allowing management of 2 doors
- Door access controlled by access templates and up to 4 weekly and/or annual holiday schedules

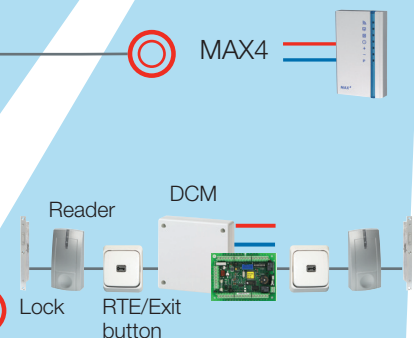

MAX4

Reader

DCM

Lock

RTE/Exit button

• 3 Box sizes to choose from

* Galaxy Flex and Galaxy Dimension

Standard Connectivity

- USB enabled for direct connect to local PC using USB cable (mini USB port)

Wireless Options

- Bi-directional wireless interface with full range of intrusion and environmental detectors
- 868MHz frequency
- Up to 8 wireless interface modules (RF portals)
- Up to 100 wireless zones and up to 98 key fobs
- Full bi-directional agile routing (patented technology)
- Compatible with all Honeywell Alpha protocol sensors

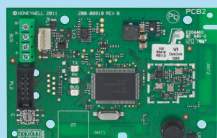

RF portal

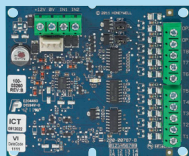

Trigger module

2-way voice device

PSTN Line



Audio interface

- 1A or 2A PSU options

External PSUs

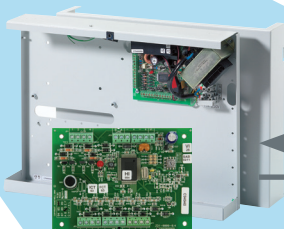

8 Inputs
4 Outputs

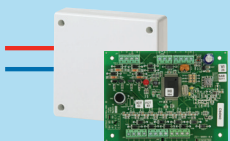

Galaxy RIO Module

8 Zones
4 Outputs



Expansion Options

- Clip in module expansion slots
- Allows total customisation depending on security needs
- Designed to host trigger and other new modules

Audio Interface Module

- Links 2 audio channels to provide audio verification following an alarm activation
- Audio interface PCB connects to panel and PSTN Phone line
- Up to 34 audio channels with audio MUX (4 channels per module)
- Individual zones can be mapped to audio channels
- Optional 5-10 seconds of Pre and post-alarm recording is stored

RS485 data line

External Power Supply Units (PSUs)

Galaxy® Power RIO 2.75A

- Rated at 1.0A
- Reports AC, Battery, fuse and tamper via RS485)
- Integrated RIO version includes 8 inputs/4 outputs

Galaxy® RIO

Provides zone and output expansion for Galaxy Systems

- 8 fully programmable zones
- 4 programmable outputs
- Tamper protection
- Rotary switch for setting module address

Get the GX Remote Control App now...

Product Type	Product Ref	Panel Firmware Requiements	Additional Hardware Required
Galaxy Flex V1	C001-xx	1.17	E080-02 or E080-04 Galaxy Ethernet Module
	C002-xx		
	C003-xx		
Galaxy Flex V3	C005-xx	C001-xx	A083-00-01 Galaxy Ethernet Module
	C006-xx		
	C007-xx		

Notes: xx - country variant, Requires IOS v7.0 and above and Android v4.0 and above.
For earlier panel firmware versions, limited functionality is still available

Download Now



Search for 'GX Remote Control' on either Google Play or Apple AppStores.

Look out for the App icon and click to download.

Via Google play Android
<https://play.google.com/store>



Via iTunes Apple
<https://itunes.apple.com>





All other company names and products are trade names, trademarks or registered trademarks of their respective companies.
Honeywell is a registered trademark of Honeywell International, Inc.

Find out more:

www.galaxyflex.com
 Fax: +44 (0) 1698 738300
 Email: securitysales@honeywell.com

Honeywell Security Group

Newhouse Industrial Estate
 Motherwell
 Lanarkshire
 ML1 5SB
 Scotland
 Tel: +44 (0)844 8000 235
www.honeywell.com



HSG-Flex-08-EN(0215)DS-E
 February 2015
 © 2015 Honeywell International Inc.

