

iDS-2CD7A47G0-XZHS(Y) 4 MP DarkfighterS DeepinView Varifocal Bullet Camera



▪ DeepinView^{series}

- High quality imaging with 4 MP resolution
- Excellent low-light performance via DarkfighterS technology
- Clear imaging against strong back light due to 140 dB WDR technology
- Efficient H.265+ compression technology to save bandwidth and storage
- 5 streams to meet a wide variety of applications
- Water and dust resistant (IP67) and vandal proof (IK10)

▪ Function

Face Recognition

With embedded deep learning based algorithms, the camera is able to give the best shot of a target face through detecting, capturing, grading and selecting. The camera uses face exposure function to dynamically adjust face area exposure of captures and ensures high face picture quality.

Perimeter Protection

With embedded deep learning based target detection and classification algorithms, the camera carries out the duty of perimeter protection, monitoring the actions of line crossing, intrusion, region entrance, and region exiting. The algorithms greatly filter out the mistaken alarm caused by the interference of leaves, lights, animal, flag, etc.

Multi-Target-Type Detection

With the embedded deep learning algorithms, the camera detects and captures the face, human body, vehicle in the specified region.

Queue Management

With embedded deep learning based algorithms, the camera detects queuing-up people number and waiting time of each person. It can generate reports to compare the efficiency of different queuing-ups and display the changing status of one queue, and supports raw data export for further analysis.

Regional People Counting

With the embedded deep learning algorithms, the camera supports people density detection and will upload detection data through scheduled uploading, number of people change uploading and congestion level uploading. It also supports number of people exception detection and waiting time exception detection.

On/Off Duty Detection

With the embedded deep learning algorithms, the camera supports absence detection and on/off duty detection. It can detect the on/off duty status and people number changes in a predefined area.

Heat Map

The camera can generate a graphic description of visits (by calculating amount of people or amount of dwell time) in a configured area.

People Counting

With the embedded deep learning algorithms, the camera integrates multiple intelligences. It counts persons and reports a face alarm simultaneously to achieve both the entrance control and people counting.

Hard Hat Detection

With the embedded deep learning algorithms, the camera detects the persons in the specified region. It detects whether the person is wearing a hard hat, and reports an alarm if not.

▪ Specification

Camera	
Image Sensor	1/1.8" Progressive Scan CMOS
Max. Resolution	2688 × 1520
Min. Illumination	Color: 0.0003 Lux @ (F1.0, AGC ON), B/W: 0.0001 Lux @ (F1.0, AGC ON), 0 Lux with light
Shutter Time	1 s to 1/100,000 s
Day & Night	IR cut filter Blue glass module (less ghost phenomenon)
Angle Adjustment	Pan: 0° to 355°, tilt: 0° to 90°, rotate: 0° to 360°
Lens	
Focal Length & FOV	2.8 to 12 mm, horizontal FOV 99.8° to 44.1°, vertical FOV 54.6° to 24.8°, diagonal FOV 113.8° to 51.1°
Focus	Auto, Semi-auto, Manual
Iris Type	P-iris
Aperture	F1.0 to F1.2
DORI	
DORI	Wide: D: 63.4 m, O: 25.2 m, R: 12.7 m, I: 6.3 m Tele: D: 140.7 m, O: 55.8 m, R: 28.1 m, I: 14.1 m
Illuminator	
Supplement Light Type	Hybrid (IR and White Light)
Supplement Light Range	Up to 50 m
Smart Supplement Light	Yes
IR Wavelength	850 nm
AI Open Platform	
Model Specification	Up to 4 models, Model type: detection model, classification model, mixed model (detection model and classification model)
Video	
Main Stream	50 Hz: 50 fps (2688 × 1520, 2560 × 1440, 1920 × 1080, 1280 × 720) 60 Hz: 60 fps (2688 × 1520, 2560 × 1440, 1920 × 1080, 1280 × 720)
Sub-Stream	50 Hz: 25 fps (704 × 576, 640 × 480) 60 Hz: 30 fps (704 × 480, 640 × 480)
Third Stream	50 Hz: 25 fps (1920 × 1080, 1280 × 720, 704 × 576, 640 × 480) 60 Hz: 30 fps (1920 × 1080, 1280 × 720, 704 × 480, 640 × 480)
Fourth Stream	50 Hz: 25 fps (704 × 576, 640 × 480) 60 Hz: 30 fps (704 × 480, 640 × 480)
Fifth Stream	50 Hz: 25 fps (704 × 576, 640 × 480) 60 Hz: 30 fps (704 × 480, 640 × 480)
Video Compression	Main stream: H.265+/H.265/H.264+/H.264, Sub-stream: H.265/H.264/MJPEG, Third stream: H.265/H.264, Fourth stream: H.265/H.264/MJPEG, Fifth stream: H.265/H.264/MJPEG
Video Bit Rate	32 Kbps to 16 Mbps
H.264 Type	Baseline Profile, Main Profile, High Profile

H.265 Type	Main Profile
Bit Rate Control	CBR, VBR
Scalable Video Coding (SVC)	H.264 and H.265 encoding
Region of Interest (ROI)	4 fixed regions for each stream
Target Cropping	Yes
Audio	
Audio Type	Mono sound
Audio Compression	G.711/G.722.1/G.726/MP2L2/PCM/MP3/AAC-LC
Audio Bit Rate	64 Kbps (G.711ulaw/G.711alaw)/16 Kbps (G.722.1)/16 Kbps (G.726)/32 to 192 Kbps (MP2L2)/8 to 320 Kbps (MP3)/16 to 64 Kbps (AAC-LC)
Audio Sampling Rate	8 kHz/16 kHz/32 kHz/44.1 kHz/48 kHz
Environment Noise Filtering	Yes
Network	
Protocols	TCP/IP, ICMP, HTTP, HTTPS, FTP, SFTP, DHCP, DNS, DDNS, SRTP, RTP, RTSP, RTCP, PPPoE, NTP, UPnP, SMTP, SNMP, IGMP, 802.1X, QoS, IPv4/IPv6, UDP, Bonjour, SSL/TLS, ARP, WebSocket, WebSockets
Simultaneous Live View	Up to 20 channels
API	Open Network Video Interface (Profile S, Profile G, Profile T), ISAPI, SDK, ISUP
User/Host	Up to 32 users 3 user levels: administrator, operator, and user
Security	Password protection, complicated password, HTTPS encryption, 802.1X authentication (EAP-TLS, EAP-LEAP, EAP-MD5), watermark, IP address filter, basic and digest authentication for HTTP/HTTPS, WSSE and digest authentication for Open Network Video Interface, RTP/RTSP OVER HTTPS, Control Timeout Settings, Security Audit Log, TLS 1.2, TLS 1.3
Network Storage	NAS (NFS, SMB/CIFS), Auto Network Replenishment (ANR) Together with high-end Hikvision memory card, memory card encryption and health detection are supported.
Client	iVMS-4200, Hik-Connect
Web Browser	Plug-in required live view: IE 10, IE11 Plug-in free live view: Chrome 57.0+, Firefox 52.0+
Image	
Image Parameters Switch	Yes
Image Settings	Saturation, brightness, contrast, sharpness, AGC, white balance, adjustable by client software or web browser
Day/Night Switch	Day, Night, Auto, Schedule, Alarm Trigger, Video Trigger
Wide Dynamic Range (WDR)	140 dB
Image Enhancement	BLC, HLC, 3D DNR, Defog, EIS
Privacy Mask	8 programmable polygon privacy masks
Picture Overlay	LOGO picture can be overlaid on video with 128 × 128 24 bit bmp format.
Interface	
Video Output	1 Vp-p Composite Output (75 Ω/CVBS) (Only for debugging)
Ethernet Interface	1 RJ45 10 M/100 M/1000 M self-adaptive Ethernet port
On-Board Storage	Built-in memory card slot, support microSD/microSDHC/microSDXC card, up to 1 TB
Alarm	2 input(s), 2 output(s) (max. 24 VDC, 1 A)

Audio	1 input (line in), 3.5 mm connector, three-contact, max. input amplitude: 3.3 Vpp, input impedance: 4.7 K Ω , interface type: non-equilibrium 1 output (line out), 3.5 mm connector, three-contact, max. output amplitude: 3.3 Vpp, output impedance: 100 Ω , interface type: non-equilibrium, mono sound
RS-485	1 RS-485 (Half duplex, HIKVISION, Pelco-P, Pelco-D, self-adaptive)
Reset Key	Yes
Power Output	12 VDC, max. 100 mA
Event	
Basic Event	Motion detection, video tampering alarm, video quality diagnosis, exception (network disconnected, IP address conflict, illegal login, abnormal reboot, HDD full, HDD error), vibration detection
Smart Event	Line crossing detection, intrusion detection, region entrance detection, region exiting detection, audio exception detection, scene change detection, defocus detection
Linkage	Upload to FTP/NAS/memory card, notify surveillance center, send email, trigger alarm output, trigger recording, trigger capture, audible warning
Deep Learning Function	
Multi-target-type Detection	Supports simultaneous detection and capture of human body, face, and vehicle, Gets 7 face features, Gets 13 human body features, Gets 2 vehicle features
Face Capture	Detects up to 60 faces simultaneously, Supports swing left and right from -60° to 60°, tilt up and down from -30° to 30°, Uploads face with background and closed-up face pictures
Face Comparison	Up to 10 face libraries. Up to 30,000 faces for each library. 150,000 faces in total. Supports face library encryption
People Counting	Supports crossline people counting, Supports counting, displaying and exporting the people flow data of entering and exiting (The data is stored in the flash), The real-time people flow data is displayed on the screen, Supports swing left and right from -60° to 60°, tilt up and down from -30° to 30°, Uploads face with background and closed-up face picture, Supports real-time uploading and uploading by statistic cycle
Queue Management	Supports up to 8 detection regions, and independent arming schedule and linkage method, Supports 2 detection modes: regional people queuing-up, waiting time detection, Generates reports to compare the efficiency of different queuing-ups and display the changing status of one queue, Supports raw data export for further analysis, Supports real-time data uploading and scheduled data uploading, Regional people queuing-up: supports 4 alarm trigger conditions, including greater than threshold, less than threshold, equal to threshold, not equal to threshold, Waiting time detection: supports 1 alarm trigger condition, including greater than threshold
Heat Map	A graphic description of visits (by calculating amount of people or amount of dwell time) in a configured area, Two report types are available, space heat map and time heat map line chart

Hard Hat Detection	<p>Detects up to 30 human targets simultaneously</p> <p>Supports up to 4 shield regions</p>
Metadata	Intrusion detection, line crossing detection, region entrance detection, region exiting detection
Regional People Counting	<p>Supports up to 8 detection regions, and independent arming schedule and linkage method,</p> <p>Supports 3 detection modes: people density detection, number of people exception detection, waiting time exception detection</p> <p>Supports parameter settings: alarm times per exception, alarm interval, first alarm delay,</p> <p>Supports searching real-time number of people,</p> <p>People density detection: supports scheduled uploading, number of people change uploading, congestion level uploading,</p> <p>Number of people exception detection: supports 6 alarm trigger conditions, including greater than threshold A, less than threshold A, equal to threshold A, not equal to threshold A, greater than threshold A and less than threshold B, less than threshold A or greater than threshold B (threshold A should be less than threshold B),</p> <p>Waiting time exception detection: supports 3 alarm trigger conditions, including greater than threshold A, less than threshold A, greater than threshold A and less than threshold B (threshold A should be less than threshold B)</p>
On/Off Duty Detection	<p>Supports up to 8 detection regions, and independent arming schedule and linkage method,</p> <p>Supports 2 detection modes: absence detection, on/off duty detection,</p> <p>Supports parameter settings: person on duty, absence duration</p>
General	
Power	<p>Three-core terminal block</p> <p>12 VDC \pm 20%, 1.90 A, max. 22.7 W</p> <p>24 VAC \pm 20%, 1.39 A, max. 22.3 W</p> <p>PoE: 802.3at, Type 2, Class 4, 42.5 V to 57 V, 0.59 A to 0.44 A, max. 24.7 W</p>
Material	Aluminum alloy body
Dimension	\varnothing 140 mm \times 378.4 mm (\varnothing 5.5" \times 14.9")
Package Dimension	425 mm \times 190 mm \times 180 mm (16.7" \times 7.5" \times 7.1")
Weight	Approx. 2280 g (5.0 lb.)
With Package Weight	Approx. 3370 g (7.4 lb.)
Storage Conditions	-40 °C to 60 °C (-40 °F to 140 °F). Humidity 95% or less (non-condensing)
Startup and Operating Conditions	-40 °C to 60 °C (-40 °F to 140 °F). Humidity 95% or less (non-condensing)
Language	33 languages: English, Russian, Estonian, Bulgarian, Hungarian, Greek, German, Italian, Czech, Slovak, French, Polish, Dutch, Portuguese, Spanish, Romanian, Danish, Swedish, Norwegian, Finnish, Croatian, Slovenian, Serbian, Turkish, Korean, Traditional Chinese, Thai, Vietnamese, Japanese, Latvian, Lithuanian, Portuguese (Brazil), Ukrainian
General Function	Heartbeat, anti-banding, one-key reset, mirror, password protection, privacy mask, watermark, IP address filter, flash log, control timeout
Heater	Yes
Demist	Yes

Approval	
EMC	FCC: 47 CFR Part 15, Subpart B CE-EMC: EN 55032: 2015, EN 61000-3-2: 2019, EN 61000-3-3: 2013 + A1: 2019, EN 50130-4: 2011 + A1: 2014 RCM: AS/NZS CISPR 32: 2015 IC: ICES-003: Issue 7 KC: KN32: 2015, KN35: 2015
Safety	UL: UL 62368-1 CB: IEC 62368-1: 2014 + A11 CE-LVD: EN 62368-1: 2014/A11: 2017 BIS: IS 13252 (Part 1): 2010/IEC 60950-1: 2005 LOA: IEC/EN 60950-1
Environment	CE-RoHS: 2011/65/EU WEEE: 2012/19/EU Reach: Regulation (EC) No 1907/2006
Protection	IP67: IEC 60529-2013, IK10: IEC 62262: 2002
Anti-Corrosion Protection	-Y model: NEMA 4X (NEMA 250-2018)
Automotive and Railway	EN50121-4
Other	PVC FREE

▪ Typical Application

Hikvision products are classified into three levels according to their anti-corrosion performance. Refer to the following description to choose for your using environment.

With -Y model: This model has MODERATE PROTECTION.

Without -Y model: This model has NO SPECIFIC PROTECTION.

Level	Description
Top-level protection	Hikvision products at this level are equipped for use in areas where professional anti-corrosion protection is a must. Typical application scenarios include coastlines, docks, chemical plants, and more.
Moderate protection	Hikvision products at this level are equipped for use in areas with moderate anti-corrosion demands. Typical application scenarios include coastal areas about 2 kilometers (1.24 miles) away from coastlines, as well as areas affected by acid rain.
No specific protection	Hikvision products at this level are equipped for use in areas where no specific anti-corrosion protection is needed.

▪ Available Model

iDS-2CD7A47G0-XZHSY (2.8 to 12 mm)

iDS-2CD7A47G0-XZHS (2.8 to 12 mm)



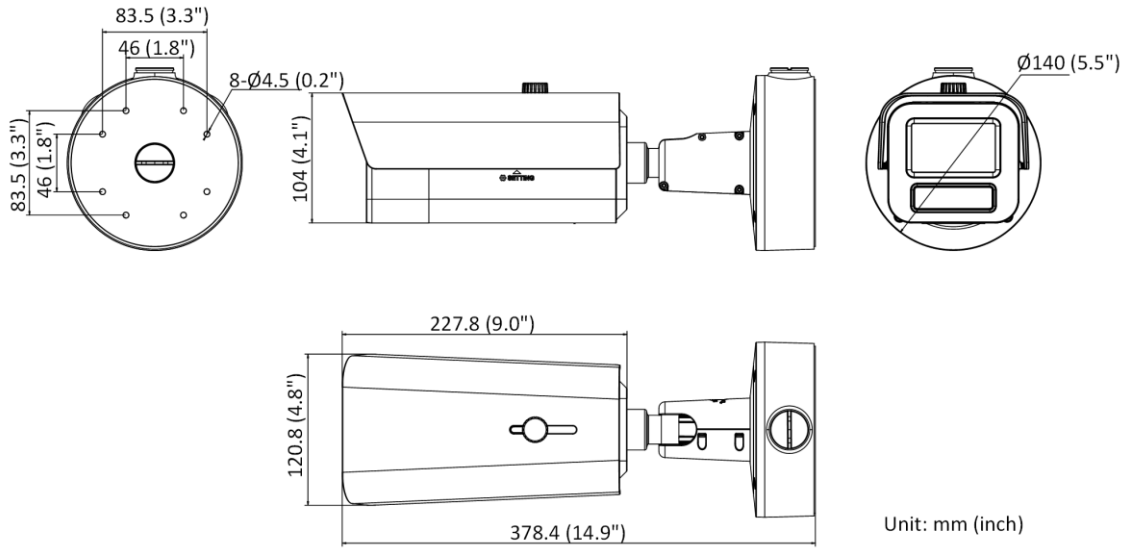

▪ Dimension



With -Y Model

▪ **Accessory**

▪ **Optional**

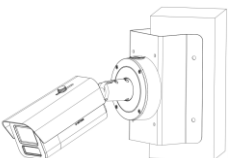
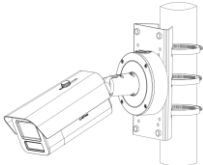
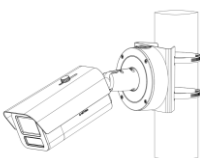
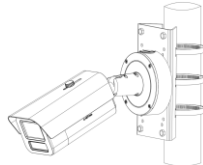
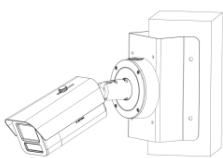
DS-1476ZJ-SUS Corner Mount	DS-1475ZJ-Y Vertical Pole Mount	DS-1275ZJ-S-SUS Vertical Pole Mount	DS-1475ZJ-SUS Vertical Pole Mount	DS-1476ZJ-Y Corner Mount
				
				

Headquarters

No.555 Qianmo Road, Binjiang District,
Hangzhou 310051, China
T +86-571-8807-5998
www.hikvision.com



Follow us on social media to get the latest product and solution information.

