

## iDS-2CD71C5G0/H-IZ(H)S(Y) 12 MP IR Varifocal Dome Network Camera



- Hikvision Embedded Open Platform 2.0 for 3rd party integration
- Supports 2 Tops computing power, 150 MB system memory, 1200 MB smart RAM, and 1288 MB eMMC storage for sharing resources
- High quality imaging with 12 MP resolution
- Excellent low-light performance via DarkFighter technology
- Clear imaging against strong back light due to DWDR technology
- Efficient H.265+ compression technology to save bandwidth and storage
- 5 streams to meet a wide variety of applications
- Water and dust resistant (IP67) and vandal proof (IK10)

## ▪ Specification

Camera	
Image Sensor	1/1.7" Progressive Scan CMOS
Max. Resolution	4000 × 3000
Min. Illumination	Color: 0.009 Lux @ (F1.2, AGC ON), B/W: 0.0009 Lux @ (F1.2, AGC ON), B/W: 0 Lux with IR
Shutter Time	1 s to 1/100,000 s
Day & Night	IR cut filter
Angle Adjustment	Pan: 0° to 355°, tilt: 0° to 75°, rotate: 0° to 355°
Lens	
Focal Length & FOV	2.8 to 12 mm, horizontal FOV 100.6° to 37.8°, vertical FOV 72.2° to 28.3°, diagonal FOV 137.3° to 47.3° 8 to 32 mm, horizontal FOV 38.1° to 13.7°, vertical FOV 28.2° to 10.4°, diagonal FOV 48.7° to 17.1°
Focus	Auto, Semi-auto, Manual
Iris Type	P-iris
Aperture	2.8 to 12 mm: F1.2, 8 to 32 mm: F1.6
DORI	
DORI	2.8 to 12 mm: D: 233.5 m, O: 92.7 m, R: 46.7 m, I: 23.4 m 8 to 32 mm: D: 627 m, O: 248.8 m, R: 125.4 m, I: 62.7 m
Illuminator	
Supplement Light Type	IR
Supplement Light Range	2.8 to 12 mm: Monitoring: 30 m; 8 to 32 mm: Monitoring: 50 m
Smart Supplement Light	Yes
IR Wavelength	850 nm
HEOP	
Open Resources	Memory: 150 MB, Smart RAM: 1200 MB, eMMC: 1288 MB
Computing Power	2 TOPS
Open Capability	HEOP 2.0 OpendevSDK
Deep Learning Structure	Caffe, PyTorch, TensorFlow
Programming Language	C, C++
Video	
Main Stream	50 Hz: 25 fps (4096 × 2160, 3840 × 2160, 3072 × 1728, 2560 × 1440, 1920 × 1080, 1280 × 720) 60 Hz: 30 fps (4096 × 2160, 3840 × 2160, 3072 × 1728, 2560 × 1440, 1920 × 1080, 1280 × 720) 50 Hz: 25 fps (4000 × 3000) 60 Hz: 30 fps (4000 × 3000)
Sub-Stream	50 Hz: 25 fps (704 × 576, 640 × 480) 60 Hz: 30 fps (704 × 480, 640 × 480)

Third Stream	50 Hz: 25 fps (1920 × 1080, 1280 × 720, 704 × 576, 640 × 480) 60 Hz: 30 fps (1920 × 1080, 1280 × 720, 704 × 480, 640 × 480)
Fourth Stream	50 Hz: 25 fps (704 × 576, 640 × 480) 60 Hz: 30 fps (704 × 480, 640 × 480)
Fifth Stream	50 Hz: 25 fps (704 × 576, 640 × 480) 60 Hz: 30 fps (704 × 480, 640 × 480)
Video Compression	Main stream: H.265+/H.265/H.264+/H.264, Sub-stream: H.265/H.264/MJPEG, Third stream: H.265/H.264, Fourth stream: H.265/H.264/MJPEG, Fifth stream: H.265/H.264/MJPEG
Video Bit Rate	32 Kbps to 16 Mbps
H.264 Type	Baseline Profile, Main Profile, High Profile
H.265 Type	Main Profile
Bit Rate Control	CBR, VBR
Scalable Video Coding (SVC)	H.264 and H.265 encoding
Region of Interest (ROI)	4 fixed regions for each stream
Target Cropping	Yes
<b>Audio</b>	
Audio Type	Mono sound
Audio Compression	G.711/G.722.1/G.726/MP2L2/PCM/MP3/AAC-LC
Audio Bit Rate	64 Kbps (G.711ulaw/G.711alaw)/16 Kbps (G.722.1)/16 Kbps (G.726)/32 to 192 Kbps (MP2L2)/8 to 320 Kbps (MP3)/16 to 64 Kbps (AAC-LC)
Audio Sampling Rate	8 kHz/16 kHz/32 kHz/44.1 kHz/48 kHz
Environment Noise Filtering	Yes
<b>Network</b>	
Protocols	TCP/IP, ICMP, HTTP, HTTPS, FTP, DHCP, DNS, DDNS, RTP, RTSP, RTCP, PPPoE, NTP, UPnP, SMTP, SNMP, IGMP, 802.1X, QoS, IPv6, UDP, Bonjour, WebSocket, WebSockets
Simultaneous Live View	Up to 20 channels
API	Open Network Video Interface (Profile S, Profile G), ISAPI, SDK, ISUP
User/Host	Up to 32 users 3 user levels: administrator, operator, and user
Security	Password protection, complicated password, HTTPS encryption, 802.1X authentication (EAP-TLS, EAP-LEAP, EAP-MD5), watermark, IP address filter, basic and digest authentication for HTTP/HTTPS, WSSE and digest authentication for Open Network Video Interface, RTP/RTSP OVER HTTPS, Control Timeout Settings, Security Audit Log, TLS 1.1, TLS 1.2, TLS 1.3
Client	iVMS-4200, Hik-Connect
Web Browser	Plug-in required live view: IE 11, Plug-in free live view: Safari 12+, Local service: Chrome 57.0+, Firefox 52.0+, Not recommended: Safari 11+, Edge
Network Storage	NAS (NFS, SMB/CIFS), Auto Network Replenishment (ANR), Together with high-end Hikvision memory card, memory card encryption and health detection are supported.

Image	
Image Parameters Switch	Yes
Image Settings	Rotate mode, saturation, brightness, contrast, sharpness, AGC, white balance, adjustable by client software or web browser
Day/Night Switch	Day, Night, Auto, Schedule, Alarm Trigger
Wide Dynamic Range (WDR)	Digital WDR
Image Enhancement	BLC, HLC, 3D DNR, Defog
Privacy Mask	8 programmable polygon privacy masks, mask color or mosaic configurable
Picture Overlay	LOGO picture can be overlaid on video with 128 × 128 24 bit bmp format.
Interface	
Video Output	1 Vp-p Composite Output (75 Ω/CVBS) (Only for debugging)
Ethernet Interface	1 RJ45 10 M/100 M/1000 M self-adaptive Ethernet port
On-Board Storage	Built-in memory card slot, support microSD/microSDHC/microSDXC card, up to 256 GB
Built-in Microphone	Yes, 2 built-in microphones
Built-in Speaker	Max. power consumption: 1.5 W, max. sound pressure level: 98 dB, speaker range: 10 m
Audio	1 input (line in), 3.5 mm connector, three-contact, max. input amplitude: 3.3 Vpp, input impedance: 4.7 KΩ, interface type: non-equilibrium, 1 output (line out), 3.5 mm connector, three-contact, max. output amplitude: 3.3 Vpp, output impedance: 100 Ω, interface type: non-equilibrium, mono sound
Alarm	2 inputs, 2 outputs (max. 24 VDC/24 VAC, 1 A)
RS-485	1 RS-485 (Half duplex, HIKVISION, Pelco-P, Pelco-D, self-adaptive)
Reset Key	Yes
Power Output	12 VDC, max. 100 mA
Event	
Basic Event	Motion detection, video tampering alarm, network disconnected, IP address conflict, illegal login, HDD full, HDD error, abnormal restart, video quality diagnosis
Smart Event	scene change detection, audio exception detection, defocus detection
Linkage	Upload to FTP/NAS/memory card, notify surveillance center, send email, trigger alarm output, trigger recording, trigger capture, audible warning
General	
Power	12 VDC ± 20%, 1.02 A, max. 12.4 W, three-core terminal block, reverse polarity protection, 24 VAC ± 20%, 0.82 A, max. 11.8 W, PoE: IEEE 802.3at, Type 2, Class 4, 42.5 V to 57 V, 0.29 A to 0.22 A, max. 12.5 W
Material	Base: metal, cover: metal
Dimension	Ø144.3 mm × 114.1 mm (Ø5.7" × 4.5")
Package Dimension	244 mm × 174 mm × 173 mm (9.6" × 6.9" × 6.8")
Weight	Approx. 945 g (2.0 lb.)
With Package Weight	Approx. 1425 g (3.0 lb.)
Storage Conditions	-40 °C to 60 °C (-40 °F to 140 °F). Humidity 95% or less (non-condensing)
Startup and Operating Conditions	With -H: -40 °C to 60 °C (-40 °F to 140 °F). Humidity 95% or less (non-condensing), Without -H: -30 °C to 60 °C (-22 °F to 140 °F). Humidity 95% or less (non-condensing)

Language	33 languages: English, Russian, Estonian, Bulgarian, Hungarian, Greek, German, Italian, Czech, Slovak, French, Polish, Dutch, Portuguese, Spanish, Romanian, Danish, Swedish, Norwegian, Finnish, Croatian, Slovenian, Serbian, Turkish, Korean, Traditional Chinese, Thai, Vietnamese, Japanese, Latvian, Lithuanian, Portuguese (Brazil), Ukrainian
General Function	Heartbeat, one-key reset, mirror, password protection, pixel counter, anti-banding
Cable Length	0.25 m (0.8 ft.)
<b>Approval</b>	
EMC	CE-EMC: EN 55032: 2015, EN 61000-3-2:2019, EN 61000-3-3: 2013+A1:2019, EN 50130-4: 2011 +A1: 2014, EN50121-4, RCM: AS/NZS CISPR 32: 2015, IC: ICES-003: Issue 7, KC: KN32: 2015, KN35: 2015
Safety	UL: UL 62368-1, CB: IEC 62368-1: 2014+A11, CE-LVD: EN 62368-1: 2014/A11: 2017, BIS: IS 13252 (Part 1): 2010/IEC 60950-1: 2005, LOA: IEC/EN 60950-1
Environment	CE-RoHS: 2011/65/EU, WEEE: 2012/19/EU, Reach: Regulation (EC) No 1907/2006
Protection	IP67: IEC 60529-2013, IK10: IEC 62262:2002
Anti-Corrosion Protection	-Y: NEMA 4X (NEMA 250-2018)
Other	PVC FREE

## ▪ Typical Application

Hikvision products are classified into three levels according to their anti-corrosion performance. Refer to the following description to choose for your using environment.

-Y model: This model has MODERATE PROTECTION.

Without -Y model: This model has NO SPECIFIC PROTECTION.

Level	Description
Top-level protection	Hikvision products at this level are equipped for use in areas where professional anti-corrosion protection is a must. Typical application scenarios include coastlines, docks, chemical plants, and more.
Moderate protection	Hikvision products at this level are equipped for use in areas with moderate anti-corrosion demands. Typical application scenarios include coastal areas about 2 kilometers (1.24 miles) away from coastlines, as well as areas affected by acid rain.
No specific protection	Hikvision products at this level are equipped for use in areas where no specific anti-corrosion protection is needed.

## ▪ Available Model

iDS-2CD71C5G0/H-IZHSY(2.8-12mm)

iDS-2CD71C5G0/H-IZHSY(8-32mm)

iDS-2CD71C5G0/H-IZS(2.8-12mm)

iDS-2CD71C5G0/H-IZS(8-32mm)



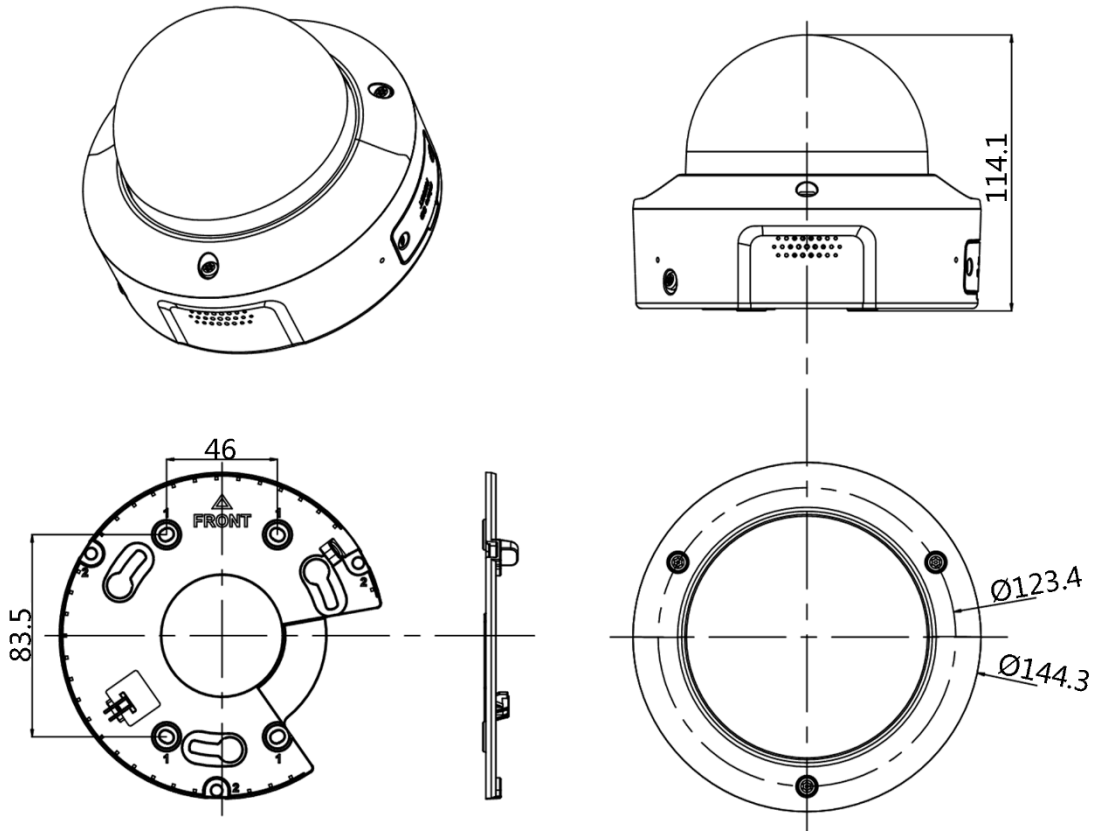





▪ Dimension



Unit: mm

▪ Accessory

▪ Optional

DS-1271ZJ-160 Pendant Mount	DS-1273ZJ-160 Wall Mount	DS-1476ZJ-SUS Corner Mount	DS-1273ZJ-160-AKS Wall Mount	DS-1475ZJ-Y Vertical Pole Mount
				
DS-1227ZJ-DM32 In-Ceiling Mount	DS-1475ZJ-SUS Vertical Pole Mount	DS-1476ZJ-Y Corner Mount		
				

\*Anti-corrosion cameras (-Y models) are recommended to be used with anti-corrosion brackets (-Y and -AKS bracket models).

**Headquarters**

No.555 Qianmo Road, Binjiang District,  
Hangzhou 310051, China  
T +86-571-8807-5998  
www.hikvision.com



Follow us on social media to get the latest product and solution information.

