

DS-MP7608HN/M12 Series Mobile Video Recorder



Key Feature

- Connects 8-ch IP cameras via PoE interfaces. Connects 8 more IP cameras via PoE switch.
- Up to 1080p resolution of H.264/H.265 compression for each IP camera.
- One CVBS video output interface.
- One VGA video output interface with up to 1080p resolution.
- Two pluggable 2.5-inch HDDs/SSDs, adopting hard disk vibration damping technology.
- Store videos that has dropped frame in SD card when HDDs/SSDs are damaged).
- Pluggable 3G/4G module and Wi-Fi module providing flexible data transmission solutions.
- Built-in GPS (Global Positioning System) module precisely positioning the vehicle via the satellite and recording the location information in the video stream.
- Information collection interfaces collecting driving information such as left/right turning, braking, reversing, etc.
- Specialized aviation connectors ensuring signal stability.
- Shutdown delay (0 h to 6 h) and 24-hour scheduled startup/shutdown.
- Back up two upgrade packages to reduce risk of failure.
- Battery protection avoids vehicle from running out of battery.
- Wide-range power input (+9 VDC to +32 VDC).
- Power-off protection prevents key data from loss.
- Supports accessing via WEB browser.
- Aluminum die-cast chassis.
- Housing is available for protecting mobile video recorder from water.

Available Model

DS-MP7608HN, ((supports M12)

DS-MP7608HN/GW/WI58, (supports M12, 3G dialing, and 5.8G Wi-Fi)

DS-MP7608HN/GLF/WI58, (supports M12, 4G dialing, and 5.8G Wi-Fi)



Specifications

Model		DS-MP7608HN/M12(/GW)(/WI)(/WI58)
Video/Audio Input	IP Camera	16 in total: 8 IP cameras connected via PoE interfaces, 8 IP cameras extendable via PoE interfaces
	Two-way Audio	1, integrated in EXT.DEV interface
Video/Audio Output	Video Output	CVBS: 1, PAL: 704 × 576, NTSC: 704 × 480 VGA: 1, 1920 × 1080, 1280 × 1024, 1280 × 720, 1024 × 768
	Audio Output	1
Encoding/Decoding parameters	Video Compression	H.264, H.265
	Encoding Resolution	Main stream: 1080p/720p/WD1/4CIF, sub-stream: 4CIF/2CIF/CIF
	Frame Rate	PAL: 1 to 25fps; NTSC: 1 to 30fps
	Audio Compression	G.722
	Stream Type	Video, video & audio
	Audio Bitrate	16 Kbps
	Dual Stream	Supported
Storage	HDD/SSD	2 × 2.5 inch HDD/SSD, up to 2 TB for each HDD/SSD Dummy HDD with USB 3.0 interface
	SD card	1 × SD card, up to 256 GB
Wireless network	3G/4G dialing	1 × 3G/4G card slot, 1 × Rosenberger antenna
	Wi-Fi	<ul style="list-style-type: none"> ● WI58 model: 2 × 5.8 G Wi-Fi SMA antenna ● WI model: 1 × 2.4 G Wi-Fi SMA antenna
Positioning	GNSS (Global Navigation Satellite System)	GPS (Global Positioning System), 1 × Rosenberger antenna
PoE	PoE Interface	8 × M12 PoE interface
	Max. Consumption	51 W
External interface	Network Interface	<ul style="list-style-type: none"> ● Front panel: 1 × 10M/100M/1000M RJ45 Ethernet interface ● Rear panel: 1 × 10M/100M/1000M M12 Ethernet interface
	Serial Port	2 × RS-232, 1 × RS-485, 1 × RS-422 (integrated in EXT.DEV interface)
	CAN interface	2
	USB Interface	<ul style="list-style-type: none"> ● Front panel: 1 × USB 3.0 ● Rear panel: 1 × USB 2.0 of 5-pin aviation plug
	Sensor-in	4 high/low level signal inputs
	Alarm Input	4 high/low level signal inputs, 1 pulse signal input, 1 BUTTON input (reserved)
	Alarm Output	2 relay signal outputs
	Operating Method	Mouse, IR remote control, Web control, and touchscreen
General	Power Supply	9 to 32 VDC
	Consumption	<ul style="list-style-type: none"> ● Standby: ≤ 0.5 W ● Full load: ≤ 99 W Note: Without peripheral and storage media ≤ 20 W
	Working Temperature	<ul style="list-style-type: none"> ● Device that provides dummy HDD with heating function: -30 °C to +60 °C (-22 °F to +140°F) ● Other devices: -10 °C to +60 °C (14 °F to 140°F)
	Working Humidity	10% to 95%
	Dimensions (W × D × H)	202 × 267.6 × 93.9 mm (8.0 × 14.5 × 3.7 inch)
	Weight (Without Storage Media)	3.66 kg (8.07 lb)

Physical Interfaces

Front Panel

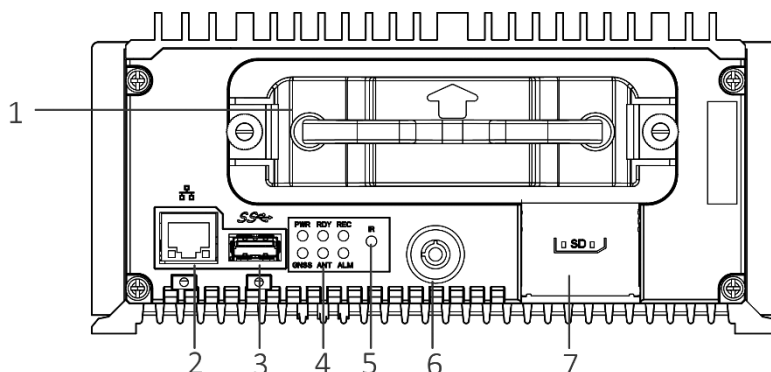



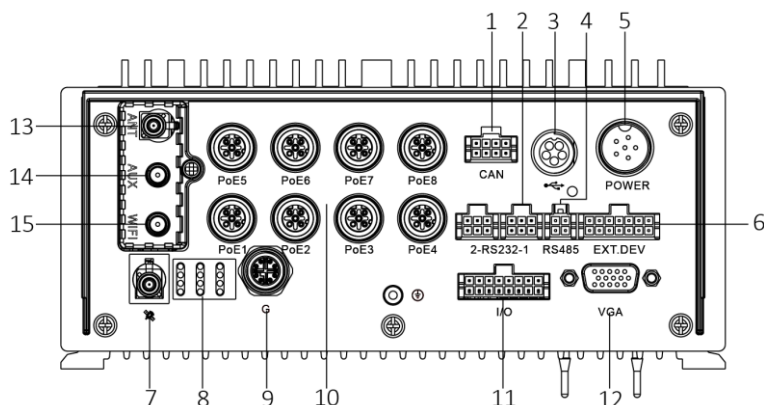

No.	Name	No.	Name
1	Dummy HDD/SSD	4	Power indicator
2	10M/100M/1000M RJ45 Ethernet interface		Ready indicator
3	USB 3.0 interface		Record indicator
5	IR receiver		GNSS indicator
6	Lock/Unlock the hard disk box.		ANT indicator
7	SD card slot		Alarm indicator

Rear Panel

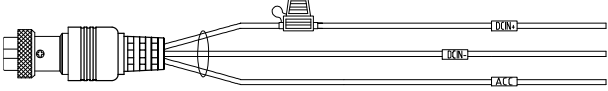
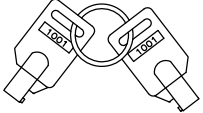
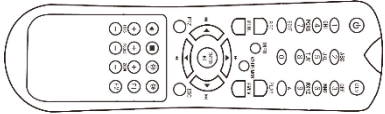
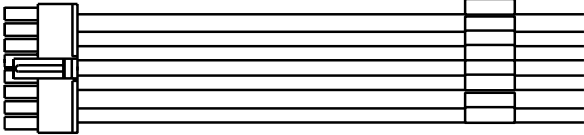
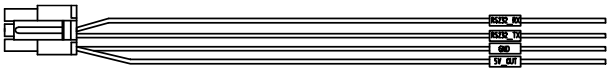
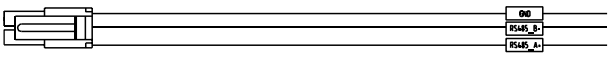
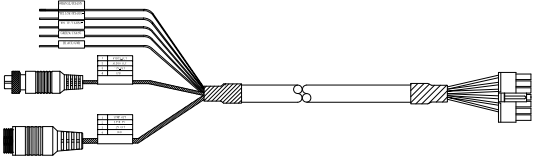

No.	Name	No.	Name
1	2 × CAN interface	9	10M/100M/1000M M12 Ethernet interface
2	2 × RS-232 interface	10	8 × M12 PoE interface
3	USB interface of 5-pin aviation plug	11	I/O interface: 4-ch alarm input, 2-ch alarm output, 4-ch sensor in, 1-ch pulse signal input
4	RS-485 interface	12	VGA video output interface
5	6-pin aviation plug for power supply	13	Main 3G/4G antenna interface
6	EXT.DEV interface: RS-422 communication interface, two-way audio interface, and CVBS video output	14	Aux Wi-Fi antenna interface
7	GNSS antenna interface	15	Main Wi-Fi antenna interface
8	Channel and network indicators		

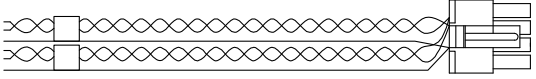
Packing List

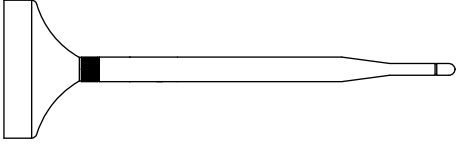
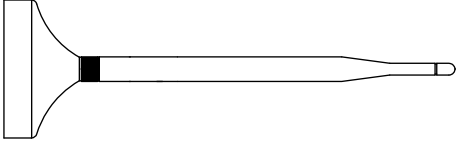
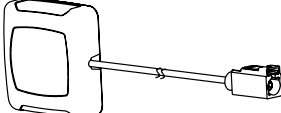
Description	Quantity	Picture	Note
Fuse	2		
Power cord	1		
Key	1		
Remote control	1		
Alarm line	1		
Serial port line	1		
485 line	1		
Extension cable	1		
Screwdriver	1		
CAN cable	1		
3G/4G antenna	1		For GW/GLF model.
Wi-Fi antenna (2.4G)	1		For WI model.
Wi-Fi antenna (5.8G)	2		For WI58 model.
GPS antenna	1		For model with GPS module.

Peripheral Connection

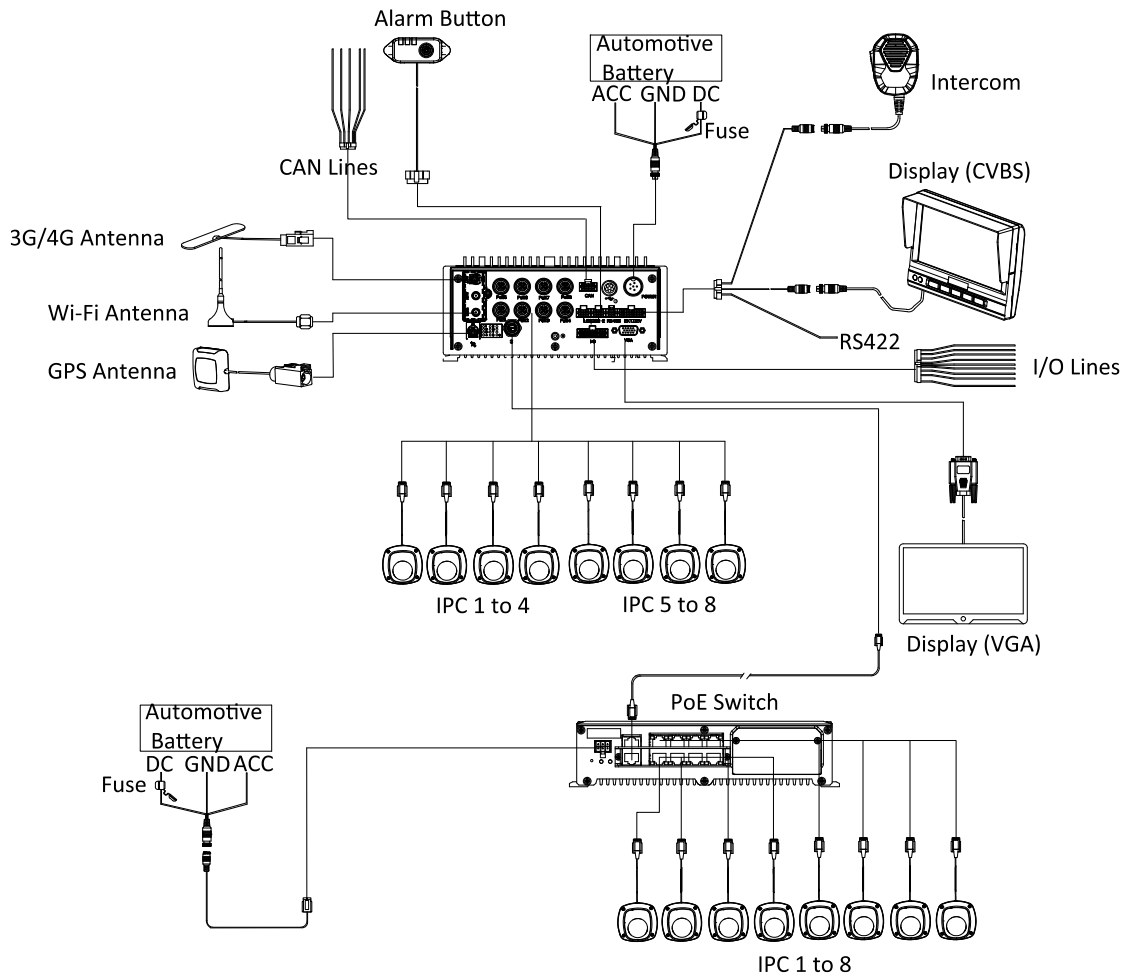

Distributed by

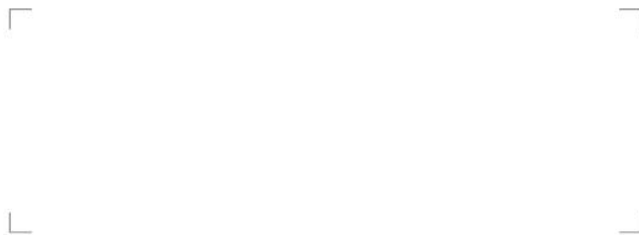

HIKVISION

Headquarters

No.555 Qianmo Road, Binjiang District,
Hangzhou 310051, China
T +86-571-8807-5998
overseasbusiness@hikvision.com

Hikvision USA
T +1-909-895-0400
sales.usa@hikvision.com

Hikvision Europe
T +31-23-55-42-770
info.eu@hikvision.com

Hikvision Middle East
T +971-4-8816086
salesme@hikvision.com

Hikvision Russia
T +7-495-669-67-99
saleru@hikvision.com

Hikvision India
T +91-22-28469900
sales@pramahikvision.com

Hikvision Italy
T +39-0438-6902
info.it@hikvision.com

Hikvision France
T +33(0)1-85-330-450
info.fr@hikvision.com

Hikvision Spain
T +34-91-737-16-55
info.es@hikvision.com

Hikvision Poland
T +48-22-460-01-50
poland@hikvision.com

Hikvision UK
T +01628-902140
support.uk@hikvision.com

Hikvision Singapore
T +65-6684-4718
sg@hikvision.com

Hikvision Oceania
T +61-2-8599-4233
salesau@hikvision.com

Hikvision Canada
T +1-909-895-0400
sales.usa@hikvision.com

Hikvision Korea
T +82-31-731-8841
sales.korea@hikvision.com

Hikvision Brazil
T +55 11 3318-0050
Latam.support@hikvision.com

Hikvision Africa
T +27 (10) 0351172
sale.africa@hikvision.com

Hikvision Hong Kong
T +852-2151-1761