

SLA-T4680A

2MP Lens Module for PNM-9000QB



FC |  | CE | EAC

Key Features

- Color: 0.06Lux(F2.5, 1/30sec)
- 4.6mm fixed focal
- Compatible with PNM-9000QB

Video	
Imaging Device	1/2.8" 2MP CMOS
Min. Illumination	Color: 0.06Lux(F2.5, 1/30sec)
Lens	
Focal Length (Zoom Ratio)	4.6mm fixed focal
Max. Aperture Ratio	F2.5
Angular Field of View	H: 73°, V: 39°, D: 85°
Mount Type	RJ12 connected with main unit
Focus Control	fixed
Mechanical	
Color / Material	Black / Plastic
Product dimensions / weight	Ø24xL49.8mm, 310g

- The latest product information / specification can be found at hanwha-security.com
- Design and specifications are subject to change without notice.
- Wisenet is the proprietary brand of Hanwha Techwin, formerly known as Samsung Techwin.

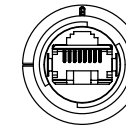
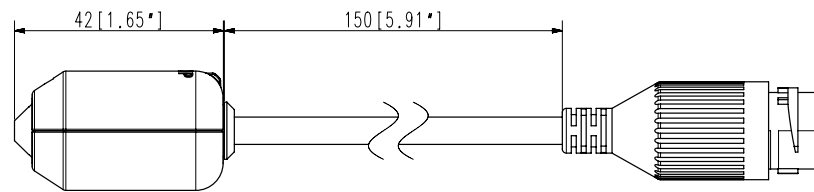
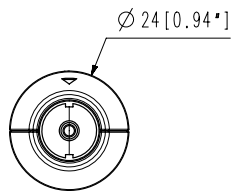
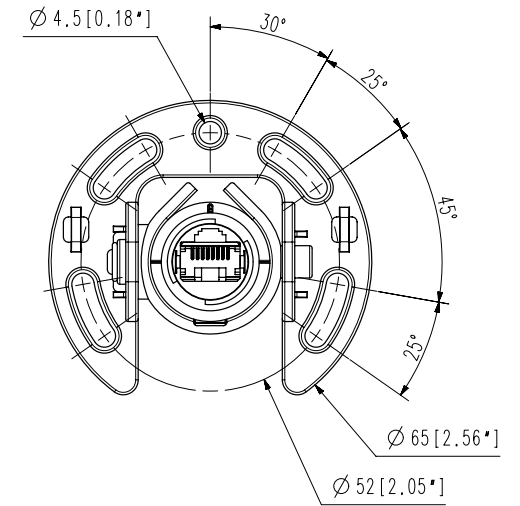
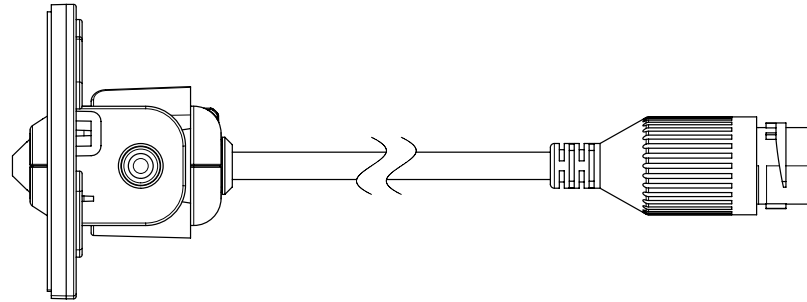
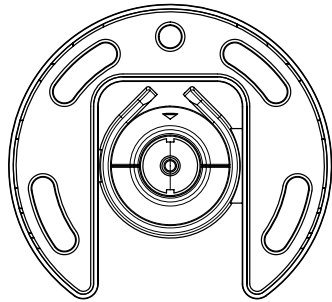
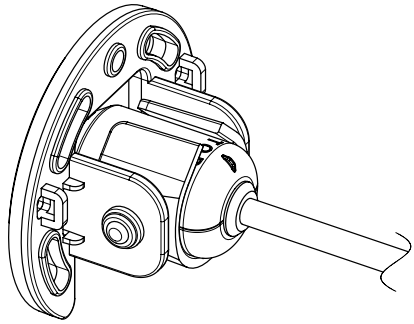

A3

© Hanwha Techwin Co.,Ltd. All rights reserved.

2	SLA-T4680A	'21.04.08
1	SLA-T4680	'17.12.05
No.	MODEL NAME	DATE

Unit:mm[inch] SCALE:1/1 Hanwha Techwin