

# Video Security



## F0612NDDC-NFS

F1.2/6mm DC Lens with No Focus Shift,  
1/3" CS Mount

Art-No. 47149



## Features

Suitable for 1/3" and 1/4" Colour and B&W Cameras  
No-Focus-Shift from Visible to Near IR Light Range  
Monofocal Length  
Aspherical Lens Elements  
CS Mount

High Standard of Optical and Mechanical Quality  
Without Built-in Auto Iris Amplifier  
4-pin Connector for DC Iris Control  
Adjustable Slip-ring Mount for Cable Positioning  
Locking Mechanism for Focusing

## Specifications

Nominal format size	1/3"
Focal length (f)	6.0mm
Aperture range (F)	F1.2-F260
Iris control system	Galvanometer
Horizontal angle of view at nominal format size	46.5°
Minimum object distance (M.O.D.)	0.2m
Focus constant range	+0.02mm (Focus deviation at switch-over to IR light at 880nm)
Flange focal length	12.5mm
Screw-in depth	4.2mm
Filter screw size	-
Slip-ring mount	340°-360° Variable adjustment range
Cable length	Approx. 20cm
4-pin plug	Standard
Lens mount	CS
Temperature range	-20°C to +50°C
Dimensions (LxDxH)	See drawing
Weight	38g

## Accessories of

<b>92486 / CG-311PA1V</b>	1/3" Day/Night Camera with Switchable IR Cut Filter, DSP, 12VDC/24VAC, 480TVL
<b>91892 / VKC-1319IR12-24</b>	1/3" Day/Night Camera with Switchable IR Cut Filter, DSP, 12VDC/24VAC, 510TVL
<b>91937 / VKC-1319/IR</b>	1/3" Day/Night Camera with Switchable IR Cut Filter, DSP, 230VAC, 510TVL
<b>91943 / VKC-1323/IR-12V</b>	1/3" Day/Night Camera with Switchable IR Cut Filter, DSP, 12VDC, 480TVL
<b>91807 / VK-1313/IR</b>	1/3" B/W IR Camera DSP, 230VAC, 590TVL
<b>91967 / VKC-1330IR12-24</b>	1/3" Day/Night Camera, DSP, EDR, RS-485, Rem. IR Cut Filter, 12VDC/24VAC, 510TVL
<b>91968 / VKC-1330/IR</b>	1/3" Day/Night Camera, DSP, EDR, RS-485, Rem. IR Cut Filter, 230VAC, 510TVL
<b>91423 / ENC-501L</b>	1/3" Network Colour Camera w. CS Mount, integr. Web Server, 5VDC/230VAC, 340TVL
<b>91438 / ENC-501W</b>	1/3" WLAN Colour Camera with Antenna CS-Mount, 6mm Lens, 5VDC/230VAC, 340TVL
<b>92488 / CG-301PA1V</b>	1/3" Day/Night Multifunction Camera with WDR, OSD, DSS, 12VDC/24VAC, 480TVL
<b>92038 / VKC-1340IR12-24</b>	1/3" Day/Night Camera, HighRes 540TVL, Removable IR Cut Filter, 12VDC/24VAC
<b>92039 / VKC-1340/IR</b>	1/3" Day/Night Camera, HighRes 540TVL, Removable IR Cut Filter, 100-240VAC
<b>92064 / VKC-1341/12-24</b>	1/3" Colour Camera, HighRes 540TVL, 12VDC/24VAC
<b>92065 / VKC-1341</b>	1/3" Colour Camera, HighRes 540TVL, 100-240VAC

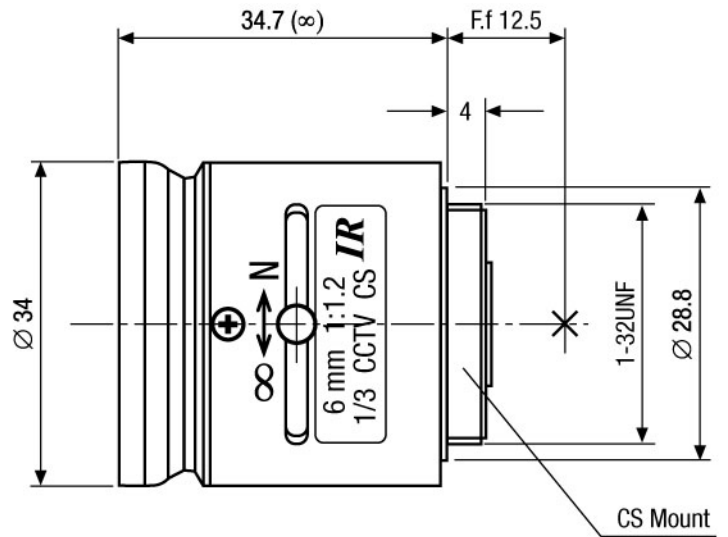
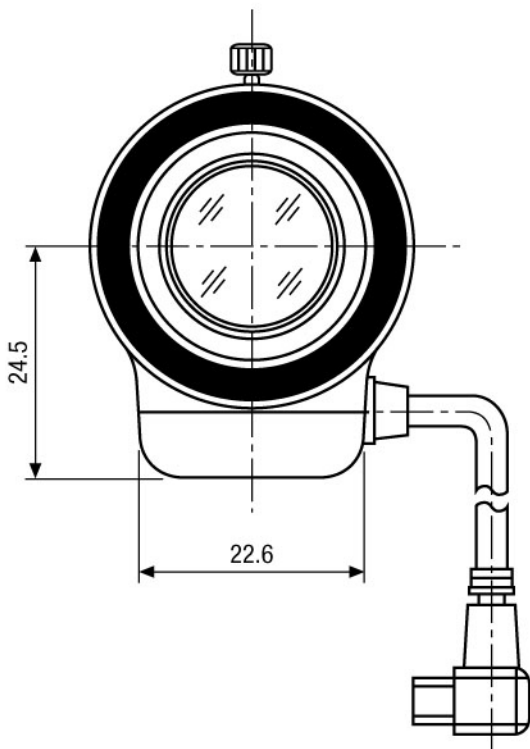

Maße/Dimensions: mm