

DH-SD6963E/65E/66E-H

18x/28x/36x IR PTZ Dome Camera



Features

- Powerful 18x/28x/36x optical zoom
- High resolution of 600TVL(Color), 650TVL(B/W)
- WDR, Day/Night (ICR), DNR (2D&3D), Auto iris, Auto focus, AWB, AGC, BLC,EIS
- Max 240°/s pan speed, 360° continuous pan rotation
- Up to 255 presets, 5 auto scan, 8 tour, 5 pattern
- Built-in 7/2 alarm in/out
- Support intelligent 3D positioning with DH-SD protocol
- IP66, IR LEDs up to 100m

DH-SD6963E/65E/66E-H

Dimensions (mm)

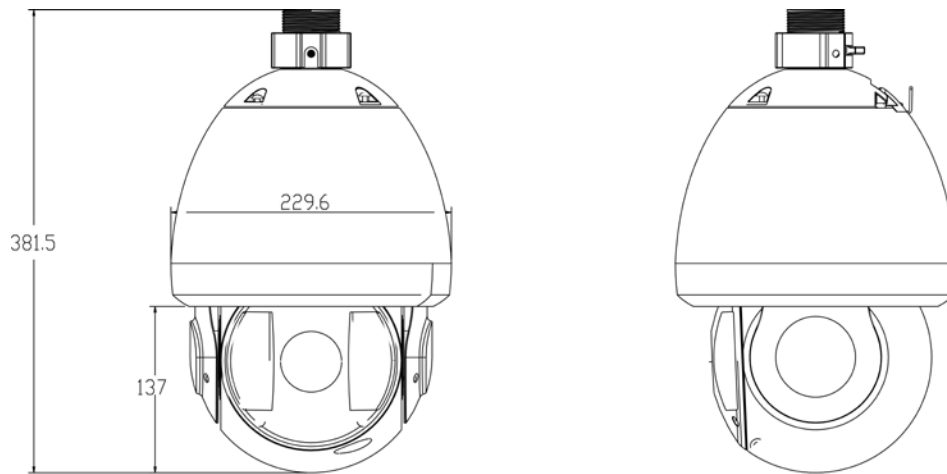

DH-SD6963E/65E/66E-H

Technical Specifications

Model	DH-SD6963E-H	DH-SD6965E-H	DH-SD6966E-H
Camera			
Image Sensor	1/4" EXview HAD CCD		
Effective Pixels	752(H) × 582(V) / 768 (H) × 494(V)		
Horizontal Resolution	Color: 600TVL; B/W: 650TVL		
Scanning System	Progressive		
Electronic Shutter Speed	1/3(4) ~ 1/10000 sec (20 steps)		
Min. Illumination	0.7 lux (F1.4, 50IRE)	0.65 lux (F1.35, 50IRE)	1.4 lux (F1.6, 50IRE)
	0.04 lux/Color	0.04 lux/Color	0.1 lux/Color
	0.01 lux/B/W, (1/3,1/4 sec)	0.005 lux/B/W, (1/3,1/4 sec)	0.01 lux/B/W, (1/3,1/4 sec)
S/N Ratio	More than 50dB		
Video Output	BNC(1.0Vp-p/75Ω), PAL / NTSC		
Camera Features			
Max IR LEDs Length	100m		
Day/Night	Auto(ICR) / Color / B/W		
Backlight Compensation	BLC / HLC / WDR		
White Balance	Auto, ATW, Indoor, Outdoor, Manual		
Gain Control	Auto / Manual		
Noise Reduction	2D / 3D		
Privacy Masking	Up to 24 areas		
Digital Zoom	12x		
Image Stabilization	Electronic Image Stabilizer (EIS)		
Lens			
Focal Length	4.1mm ~ 73.8mm (18x optical zoom)	3.5mm ~ 98.0mm (28x optical zoom)	3.4mm~ 122.4mm (36x optical zoom)
Max Aperture	F1.4 ~ F3.0	F1.35 ~ F3.7	F1.6 ~ F4.5
Focus Control	Auto / Manual		
Angle of View	H: 48°~ 2.8°	H:55.8° ~ 2.1°	H:57.8°~ 1.7°
Close Focus Distance	10mm ~ 800mm	10mm ~ 1500mm	10mm ~ 1500mm
PTZ			
Pan/Tilt Range	Pan: 0° ~ 360° endless; Tilt: -2° ~ 90°, auto flip 180°		
Manual Control Speed	Pan: 0.1° ~ 160°/s; Tilt: 0.1° ~120°/s		
Preset Speed	Pan: 240°/s; Tilt: 200°/s		
Preset	80(DH-SD) , 255(Pelco-P/D)		
PTZ Mode	5 Pattern, 8 Tour, Auto Pan, Auto Scan		
Speed Setup	Human-oriented focal length / speed adaptation		
Power up Action	Auto restore to previous PTZ and lens status after power failure		
Idle Motion	Activate Preset/Pan/Scan/Tour/Pattern if there is no command in the specified period		

DH-SD6963E/65E/66E-H

Time Task	Auto activation of Preset/Pan/Scan/Tour/Pattern by preset-time
Protocol	DH-SD, Pelco-P/D (Auto recognition)
Auxiliary Interface	
RS485	1 port
Alarm	7/2 channel In/Out
General	
Power Supply	AC24V/3A ($\pm 10\%$), DC12V optional
Power Consumption	17W, 35W (IR on)
Working Environment	-40°C ~ 60°C / Less than 90% RH
Ingress Protection	IP66
Dimensions	$\Phi 229.6(\text{mm}) \times 381.5(\text{mm})$
Weight	6.0kg

Dahua Technology Co., Ltd.

1187 BinAn Road, Binjiang District, Hangzhou, China

Tel: +86-571-87688883

Fax: +86-571-87688815

Email: overseas@dahuatech.com

www.dahuatech.com

*Design and specifications are subject to change without notice.

© 2012 Dahua Technology Co., Ltd.