

DH-HAC-HFW1239TU-Z-A-LED-DP

2MP Full-color HDCVI Bullet Camera



* The parameters and datasheets below can only be applied to 1239-S2 series.

- 24/7 color imaging, Max. 30 fps@1080p
- Super Adapt, 130 dB true WDR, 3D NR
- Auto focus, 2.7 mm–13.5 mm motorized lens
- 60 m illumination distance
- Built-in mic
- CVI/CVBS/AHD/TVI switchable
- IP67, AC 24V/DC 12V



System Overview

Lite Series is suitable for users who requires high quality monitoring products at a reasonable price. It is cost effective and offers high performance, which makes it an ideal choice for residential and small-medium business applications. This series offers an option of a wide range of technologies such as Full-color and Starlight, providing various solutions for different scenarios.

Functions

Full-color

Full-color camera adopts large aperture lens and high performance sensor. With higher amount of absorbed light and advanced image processing algorithm, the camera provides 24/7 color monitoring that collects clear and vivid information, significantly increasing probability of gathering valid human, vehicle, and event evidence that can be used for further intelligent analysis.

Broadcast-quality Audio

Audio information is used as supplementary evidence in video surveillance applications. The HDCVI camera supports audio signal transmission over coaxial cable. In addition, it adopts unique audio processing and transmission technology that best restores source audio and eliminates noise, guaranteeing the quality and effectiveness of collected audio information.

Wide Dynamic Range

With advanced Wide Dynamic Range (WDR) technology, Dahua HDCVI camera provides clear details in the environment of strong brightness contrast. The bright and dark area can get clear video even in high brightness environment or with backlight shadow.

Super Adapt

Embedded with intelligent algorithm, for changing external environment, camera can automatically adjust parameters to present the optimal image, and it solves the trouble of configuration.

Advanced 3DNR

3DNR is noise reduction technology that detects and eliminates random noises by comparing two sequential frames. Dahua's advanced 3DNR technology allows remarkable noise reduction with little impact to sharpness, especially under limited lighting condition. Besides, the advanced 3DNR effectively decreases the band width and saves the storage space.

Warm Supplemental lights

With warm supplemental LED lights, the camera is able to provide a colorful and vivid image even in total darkness. By default, the camera is set to smart light mode, in which the camera can automatically adjust the exposure time and light sensitivity simultaneously to avoid overexposure of the objects in the image center.

4 Signals over 1 Coaxial Cable

HDCVI technology supports 4 signals to be transmitted over 1 coaxial cable simultaneously, i.e. video, audio*, data and power. Dual-way data transmission allows the HDCVI camera to interact with the XVR, such as sending control signal or triggering alarm. Moreover, HDCVI technology supports PoC for construction flexibility.

* Audio input is available for some models of HDCVI cameras.

Long Distance Transmission

HDCVI technology guarantees real-time transmission at long distance without any loss. It supports up to 700 m transmission for 2MP/5MP/8MP HD video via coaxial cable, and up to 300 m via UTP cable.

*Actual results verified by real-scene testing in Dahua's test laboratory.

Protection (IP67)

IP67: The camera passes a series of strict test on dust and soak. It has dust-proof function, and the enclosure can work normal after soaking in 1 m deep water for 30 minutes.

Technical Specification

Camera

Image Sensor	1/2.8" CMOS
Max. Resolution	1920 (H) × 1080 (V)
Pixel	2MP
Scanning System	Progressive
Electronic Shutter Speed	PAL: 1/25 s–1/100000 s NTSC: 1/30 s–1/100000 s
S/N Ratio	>65 dB
Min. Illumination	0.001 Lux/F1.2, 30IRE, 0 Lux LED on
Illumination Distance	60 m (196.9 ft)
Illuminator On/Off Control	Auto; manual
Illuminator Number	4
Pan/Tilt/Rotation Range	Pan: 0°–360° Tilt: 0°–90° Rotation: 0°–360°

Lens

Lens Type	Motorized vari-focal				
Auto Focus	Yes				
Mount Type	φ16				
Focal Length	2.7 mm–13.5 mm				
Max. Aperture	F1.2				
Field of View	Diagonal: 39°–130° Horizontal: 34°–107° Vertical: 19°–56°				
Iris Type	Fixed iris				
Close Focus Distance	1.5 m (4.9 ft)				
DORI Distance	Lens	Detect	Observe	Recognize	Identify
	2.7 mm	44.9 m (147.3 ft)	17.9 m (58.7 ft)	8.9 m (29.2 ft)	4.5 m (14.8 ft)
	13.5 mm	128.6 m (421.9 ft)	51.4 m (168.6 ft)	25.7 m (84.3 ft)	12.8 m (42 ft)

Video

Frame Rate	CVI: PAL: 1080p@25 fps; NTSC: 1080p@30 fps; AHD: PAL: 1080p@25 fps; NTSC: 1080p@30 fps; TVI: PAL: 1080p@25 fps; NTSC: 1080p@30 fps; CVBS: PAL: 960 × 576H; NTSC: 960 × 480H;
Resolution	1080P (1920 × 1080); 960H (960 × 576/960 × 480);
BLC	BLC/WDR/HLC
WDR	130 dB
White Balance	Auto;Area WB

Gain Control	Auto; manual
Noise Reduction	3D NR
Smart Light	Yes
Mirror	Off/On
Privacy Masking	Off/On (8 area, rectangle)

Certifications

Certifications	CE (EN55032, EN55024, EN50130-4) FCC (CFR 47 FCC Part 15 subpartB, ANSI C63.4-2014) UL (UL60950-1+CAN/CSA C22.2 No.60950-1)
----------------	---

Port

Video Output	Video output choices of CVI/TVI/AHD/CVBS by one BNC port
Audio Input	One channel built-in mic

Power

Power Supply	AC 24V ±25%/DC 12V ±10%
Power Consumption	Max 13.2W (12V DC, LED on)

Environment

Operating Temperature	–30°C to +60°C (-22°F to 140°F);< 95% (non-condensation)
Storage Temperature	–30°C to +60°C (-22°F to 140°F);< 95% (non-condensation)
Protection Grade	IP67

Structure

Casing	Metal throughout the whole casing
Camera Dimensions	244.1 mm × 90.4 mm × 90.4 mm (9.61" × 3.56" × 3.56")
Net Weight	0.79 kg (1.7 lb)
Gross Weight	1.07 kg (2.4 lb)

Ordering Information		
Type	Part Number	Description
2MP Camera	DH-HAC-HFW1239TUP-Z-A-LED-DP	2MP Full-color HDCVI Bullet Camera, PAL
	DH-HAC-HFW1239TUN-Z-A-LED-DP	2MP Full-color HDCVI Bullet Camera, NTSC
Accessories	PFA135	Junction box
	PFA130-E	Water-proof Junction Box
	PFA152-E+PFA130-E	Pole Mount Bracket + Water-proof Junction Box
	PFM800-E	Passive HDCVI Balun
	PFM320D	12V 2A Power Adapter
	PFM820	UTC Controller
	PFM904	Integrated Mount Tester

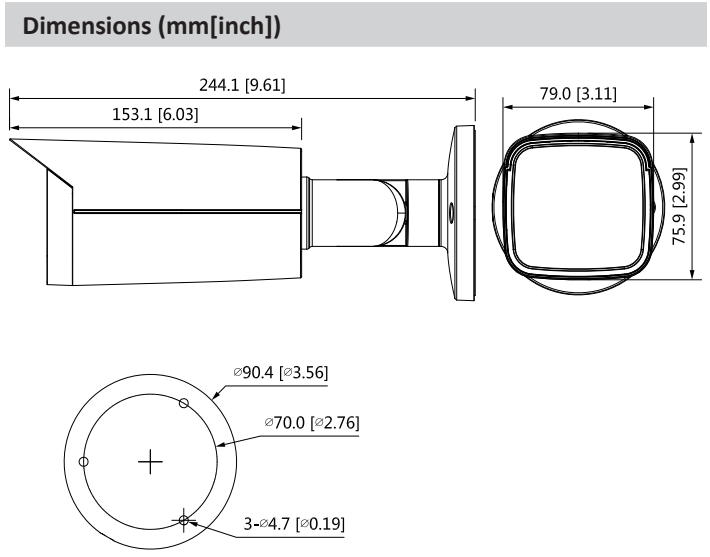

Accessories

Optional:



PFA135
Junction Box



PFA130-E
Water-proof Junction Box



PFA152-E+PFA130-E
Pole Mount Bracket +
Water-proof Junction Box



PFM800-E
Passive HDCVI Balun



PFM320D
12V 2A Power Adapter



PFM820
UTC Controller



PFM904
Integrated Mount Tester

Ceiling Mount	Junction Mount	Pole Mount (Vertical)
