

FLEXIDOME IP turret 3000i IR



The FLEXIDOME IP turret 3000i IR is built for high quality, 24/7 performance, with a range of reliable surveillance features, including Essential Video Analytics.

The compact and minimalist design provides ease of installation.

Functions

Essential Video Analytics

The built-in video analysis reinforces the Intelligence-at-the-Edge concept and now delivers even more powerful features. Essential Video Analytics is ideal for use in controlled environments with limited detection ranges.

The system reliably detects, tracks, and analyzes objects, and alerts you when predefined alarms are triggered. A smart set of alarm rules makes complex tasks easy and reduces false alarms to a minimum. Metadata is attached to your video to add sense and structure. This enables you to quickly retrieve the relevant images from hours of stored video. Metadata can also be used to deliver irrefutable forensic evidence or to optimize business processes based on people counting or crowd density information.

High Dynamic Range

The high dynamic range mode is based on a multiple-exposure process that captures more details in the highlights and in the shadows even in the same scene. The result is that you can easily distinguish objects and features, for example, faces with bright backlight.



- ▶ 1080p and 5MP resolutions
- ▶ Built-in Essential Video Analytics to trigger relevant alerts and quickly retrieve data
- ▶ Fully configurable H.265 multi-streaming
- ▶ High Dynamic Range (120 dB) for challenging bright and dark scenes
- ▶ Built-in IR illuminator with 15 m (49 ft) viewing distance

The actual dynamic range of the camera is measured using Opto-Electronic Conversion Function (OECF) analysis according to IEC 62676 Part 5.

Intelligent streaming

Smart encoding capabilities, together with Intelligent Dynamic Noise Reduction technology and analytics, reduce the bandwidth consumption to extremely low levels. Only relevant information in the scene, like motion, or objects found with the analytics, need to be encoded.

The camera is capable of triple streaming which allows the camera to deliver independent, configurable streams for live viewing, recording, or remote monitoring via constrained bandwidths. Each of these streams can be adapted independently to deliver high quality video, perfectly tailored to purpose, while reducing bit rate by up to 90% compared to a standard camera.

H.265 high-efficiency video encoding

The camera is designed on the most efficient and powerful H.264 and H.265/HEVC encoding platform. The camera is capable of delivering high-quality and high-resolution video with very low network load. With a doubling of encoding efficiency, H.265 is the compression standard of choice for IP video surveillance systems.

Tamper and motion detection

A wide range of configuration options is available for alarms signaling camera tampering. A built-in algorithm for detecting movement in the video can also be used for alarm signaling.

Built-in microphone and audio alarm

The camera has a built-in microphone to allow operators to listen in on the monitored area. Audio detection can be used to generate an alarm if needed.

Recording and storage management

Recording management can be controlled by the Bosch Video Recording Manager application, or the camera can use local storage and iSCSI targets directly without any recording software. Local storage can be used for recording "at the edge" or for Automatic Network Replenishment (ANR) technology to improve the overall recording reliability. Pre-alarm recording in RAM reduces bandwidth consumption on the network and extends the effective life of the memory card.

Edge recording

Insert a memory card into the card slot to store up to 2 TB of local alarm recording. Pre-alarm recording in RAM reduces recording bandwidth on the network, and extends the effective life of the memory card. It has advanced edge recording providing a reliable storage solution possible due to the combination of these functions:

- Industrial SD card support allows for extreme lifetime
- Health monitoring of industrial SD cards provide early service indications.

DORI coverage

DORI (Detect, Observe, Recognize, Identify) is a standard system (EN-62676-4) for defining the ability of a person viewing the video to distinguish persons or objects within a covered area. The maximum distance at which a camera/lens combination can meet these criteria is shown below:

1080p camera with 2.3 mm or 2.8 mm lens

DORI	DORI definition	Distance 2.3 mm/2.8 mm	Horizontal width
Detect	25 px/m (8 px/ft)	17 m/28 m (56 ft/93 ft)	77 m (252 ft)
Observe	63 px/m (19 px/ft)	7 m/11 m (22 ft/37 ft)	30 m (100 ft)
Recognize	125 px/m (38 px/ft)	3 m/6 m (11 ft/19 ft)	15 m (50 ft)

DORI	DORI definition	Distance 2.3 mm/2.8 mm	Horizontal width
Identify	250 px/m (76 px/ft)	2 m/3 m (6 ft/9 ft)	8 m (25 ft)

5.3MP camera with 2.3 mm or 2.8 mm lens

DORI	DORI definition	Distance 2.3 mm/2.8 mm	Horizontal width
Detect	25 px/m (8 px/ft)	37 m/57 m (121 ft/188 ft)	123 m (403 ft)
Observe	63 px/m (19 px/ft)	15 m/23 m (48 ft/75 ft)	49 m (160 ft)
Recognize	125 px/m (38 px/ft)	7 m/11 m (24 ft/38 ft)	25 m (81 ft)
Identify	250 px/m (76 px/ft)	4 m/6 m (12 ft/19 ft)	12 m (40 ft)

True day/night switching

The camera incorporates mechanical filter technology for vivid daytime color and exceptional night-time imaging while maintaining sharp focus under all lighting conditions.

Easy installation

Power for the camera can be supplied via a Power-over-Ethernet compliant network cable connection. With this configuration, only a single cable connection is required to view, power, and control the camera. Using PoE makes installation easier and more cost-effective, as cameras do not require a local power source.

The camera can also be supplied with power from +12 VDC power supplies.

For trouble-free network cabling, the camera supports Auto-MDIX which allows the use of straight or cross-over cables.

Data security

Special measures have been put in place to ensure the highest level of security for device access and data transport. The three-level password protection with security recommendations allows users to customize device access. Web browser access can be protected using HTTPS and firmware updates can also be protected with authenticated secure uploads. The on-board Trusted Platform Module (TPM) and Public Key Infrastructure (PKI) support, guarantee superior protection from malicious attacks. The 802.1x network authentication with EAP/TLS, supports TLS 1.2 with updated cipher suites including AES 256 encryption.

The advanced certificate handling offers:

- Self-signed unique certificates automatically created when required
- Client and server certificates for authentication
- Client certificates for proof of authenticity
- Certificates with encrypted private keys

System integration and ONVIF conformance

The camera conforms to the ONVIF Profile S, ONVIF Profile G and ONVIF Profile T specifications. For H.265 configuration, the camera supports Media Service 2, which is part of ONVIF Profile T. Compliance with these standards guarantees interoperability between network video products regardless of manufacturer. Third-party integrators can easily access the internal feature set of the camera for integration into large projects. Visit the Bosch Integration Partner Program (IPP) website (ipp.boschsecurity.com) for more information.

Certifications and approvals

Standard	Type
Emission	EN 55032 CFR 47 FCC part 15, Class B AS/NZS CISPR 32
Immunity	EN 50130-4 EN 50121-4
Environmental	EN 50130-5 (Class II); EN 60068-2-1, EN 60068-2-2, EN 60068-2-6, EN 60068-2-18, EN 60068-2-27, EN 60068-2-30, EN 60068-2-75, EN 60068-2-78
Safety	EN 62368-1 UL 62368-1 CAN/CSA-C22.2 No. 60950-1 IEC 62471
Image performance	IEC 62676-5
HD	SMPTE 296M-2001 (Resolution: 1280x720) SMPTE 274M-2008 (Resolution: 1920x1080)
Color representation	ITU-R BT.709-6
ONVIF conformance	EN 50132-5-2 EN 62676-2
Impact protection	EN 62262 (IK08)
Environmental	EN 50581 (RoHS)

Standard	Type
Marks	FCC, cULus, WEEE, RCM, VCCI, CMIM, EAC

Region	Regulatory compliance/quality marks	
Europe	CE	FLEXIDOME IP 3000i IR FLEXIDOME IP micro 3000i FLEXIDOME IP turret 3000i IR DINION IP 3000i IR

Installation/configuration notes

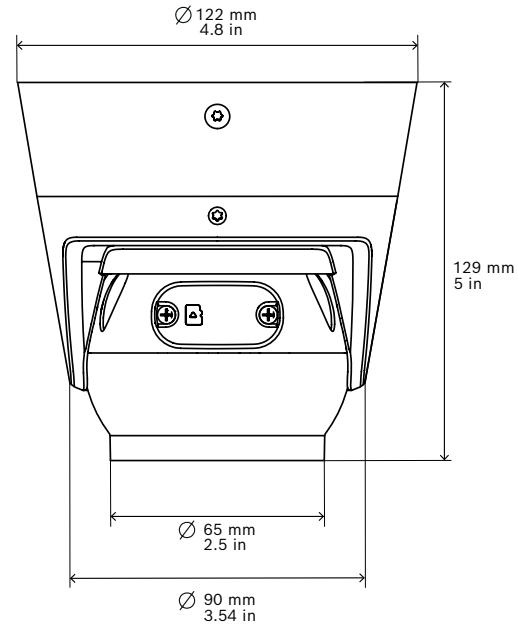

Technical specifications

Power	
Input voltage	POE IEEE 802.3af / 802.3 at Type 1, Class 3 12 VDC \pm 30%
Power consumption (typical / maximum)	PoE: 3.5 W / 10.5 W 12 VDC: 3.1 W / 9.5 W

Sensor - 2 MP	
Sensor type	1/2.8 inch CMOS
Effective pixels	1920 (H) x 1080 (V)

Sensor - 5.3 MP	
Sensor type	1/2.9 inch CMOS
Effective pixels	3072 (H) x 1728 (V)

Video performance - Sensitivity

2MP
Measured according to IEC 62676 Part 5 (1/30, F1.6 or F2.2)

Video performance - Sensitivity	
• Color	0.1 lx
• Mono	0.02 lx
• With IR	0.0 lx

5.3MP

Measured according to IEC 62676 Part 5 (1/30, F1.6 or F2.2)

• Color	0.5 lx
• Mono	0.08 lx
• With IR	0.0 lx

Video performance - Dynamic range

High Dynamic Range 120 dB WDR

Measured according to IEC 62676 Part 5

2 MP	103 dB
5.3 MP	101 dB

Optical

Lens type	2.3 mm fixed, F2.2 2.8 mm fixed, F1.6
Day/Night	Switchable IR-cut filter
Field of view	
2 MP	2.3 mm: 132° x 77° (H x V) 2.8 mm: 107° x 57° (H x V)
5.3 MP	2.3 mm: 118° x 69° (H x V) 2.8 mm: 94° x 51° (H x V)

Night vision

Distance	15 m (49 ft)
LED	2 LEDs, 850 nm
IR intensity	Adjustable

Video streaming

Video compression	H.265; H.264; M-JPEG
Sensor modes	
2 MP	30 fps, HDR, 1920 x 1080 25 fps, HDR, 1920 x 1080
5.3 MP	20 fps, HDR, 3072 x 1728 (5.3 MP) 25 fps, HDR, 2720 x 1530 (4.1 MP)

Video streaming	
Streaming	Multiple configurable streams in H.264 or H.265 and M-JPEG, configurable frame rate and bandwidth. Regions of Interest (ROI)
GOP structure	IP

Encoding interval

2 MP	1 to 30 fps
5.3 MP	1 to 20 fps (5.3 MP) 1 to 25 fps (4.1 MP)
Signal-to-noise ratio (SNR)	>55 dB

Video resolution

2 MP	
1080p HD	1920 x 1080
720p HD	1280 x 720
SD	768 x 432
D1	720 x 480
VGA	640 x 480
5.3 MP	
5.3 MP	3072 x 1728
4.1 MP	2720 x 1530
3 MP	2304 x 1296
1080p	1920 x 1080
720p	1280 x 720
SD	768 x 432
D1	720 x 480
VGA	640 x 480

Camera installation

Mirror image	On / Off
Rotation	0° / 90° upright / 180° / 270° upright

Camera installation	
Camera LED	Enable / Disable
Video functions - color	
Adjustable picture settings	Contrast, Saturation, Brightness
White Balance	2500 to 10000K, 4 automatic modes (Basic, Standard, Sodium lamp, Dominant color), Manual mode and Hold mode
Video functions - ALC	
Shutter	Automatic Electronic Shutter (AES); Fixed (1/25[30] to 1/15000) selectable; Default shutter
Day/Night	Auto (adjustable switch points), Color, Monochrome
Video functions - enhance	
Sharpness	Sharpness enhancement level selectable
Backlight compensation	On/off
Contrast enhancement	On/off
Noise reduction	Intelligent Dynamic Noise Reduction with separate temporal and spatial adjustments
Intelligent defog	Intelligent Defog automatically adjusts parameters for best picture in foggy or misty scenes (switchable)
Video content analysis	
Analysis type	Essential Video Analytics
Features	Rule based alarms and tracking, Line crossing, Enter / leave field, Follow route, Loitering, Idle / removed object, People counting, Crowd density estimation, 3D tracking
Additional functions	
Privacy Masking	Eight independent areas, fully programmable
Display stamping	Name, Logo, Time; Alarm message
Pixel counter	Selectable area
Local storage	
Internal RAM	up to 5 s pre-alarm recording
Memory card slot	microSDHC / microSDXC SD card slot

Local storage	
Industrial SD cards	Extreme lifetime and health monitoring support that provides early service indication
Input/output	
Audio input	Built-in mic
Audio line out	16 Ohm typical; output 0.875 Vrms
Alarm input	Short or DC 5 V activation
Alarm output	Maximum load: 12 VDC / 50 mA
Ethernet	RJ45 connector
Audio streaming	
Standard	G. 711, 8 kHz sampling rate L16, 16 kHz sampling rate AAC-LC, 48 kbps at 16 kHz sampling rate AAC-LC, 80 kbps at 16 kHz sampling rate
Signal-to-Noise Ratio	>50 dB
Audio Streaming	Full-duplex / half duplex
Network	
Protocols	IPv4, IPv6, UDP, TCP, HTTP, HTTPS, RTP/RTCP, IGMP V2/V3, ICMP, ICMPv6, RTSP, FTP, ARP, DHCP, APIPA (Auto-IP, link local address), NTP (SNTP), SNMP (V1, V3, MIB-II), 802.1x, DNS, DNSv6, DDNS (DynDNS.org, selfHOST.de, no-ip.com), SMTP, iSCSI, UPnP (SSDP), DiffServ (QoS), LLDP, SOAP, Dropbox™, CHAP, digest authentication
Encryption	TLS1.0/1.2, AES128, AES256
Ethernet	10/100 Base-T
Interoperability	ONVIF Profile S; ONVIF Profile G; ONVIF Profile T: GB/T 28181
Mechanical	
Dimensions (Ø x H)	122 x 129 mm (4.8 x 5.1 in)
Weight (approx.)	576 g (1.3 lbs)
Mounting	Surface mount
Color	White (RAL9003)
3-axis adjustment (pan/tilt/rotation)	Pan: 0° to 350° Tilt: 0° to 78°

Mechanical	
	Roll: 0° to 360°
Environmental	
Operating temperature (continuous)	-20 °C to +50 °C (-4 °F to +122 °F)
Storage temperature	-30 °C to +70 °C (-22 °F to +158 °F)
Humidity	5% to 100% relative humidity (condensing) 5% to 93% relative humidity (non condensing)
Storage humidity	Up to 98% relative humidity
Impact resistance	IK08
Water/dust protection	IP42

Ordering information

NTV-3502-F02L Turret camera 2MP HDR 130° IK08 IR
IP turret camera with tamper and motion detection; 2MP HD 1080p resolution; 130° lens; with built-in IR illuminator; indoor; EVA.
Order number **NTV-3502-F02L | F.01U.386.154**
F.01U.360.364

NTV-3502-F03L Turret camera 2MP HDR 100° IK08 IR
IP turret camera with tamper and motion detection; 2MP HD 1080p resolution; 100° lens; with built-in IR illuminator; indoor; EVA.
Order number **NTV-3502-F03L | F.01U.386.155**
F.01U.360.363

NTV-3503-F02L Turret camera 5MP HDR 120° IK08 IR
IP turret camera with tamper and motion detection; 5MP 1080p resolution; 120° lens; with built-in IR illuminator; indoor; EVA.
Order number **NTV-3503-F02L | F.01U.386.156**
F.01U.360.362

NTV-3503-F03L Turret camera 5MP HDR 100° IK08 IR
IP turret camera with tamper and motion detection; 5MP 1080p resolution; 100° lens; with built-in IR illuminator; indoor; EVA.
Order number **NTV-3503-F03L | F.01U.386.157**
F.01U.360.361

NTV-3502-F02L-P Turret camera 2MP HDR 130° IK08 IR
IP turret camera with tamper and motion detection; 2MP HD 1080p resolution; 130° lens; with built-in IR illuminator; indoor; EVA.
Order number **NTV-3502-F02L-P | F.01U.396.872**

NTV-3502-F03L-P Turret camera 2MP HDR 100° IK08 IR
IP turret camera with tamper and motion detection; 2MP HD 1080p resolution; 100° lens; with built-in IR illuminator; indoor; EVA.
Order number **NTV-3502-F03L-P | F.01U.396.873**

NTV-3503-F02L-P Turret camera 5MP HDR 120° IK08 IR
IP turret camera with tamper and motion detection; 5MP 1080p resolution; 120° lens; with built-in IR illuminator; indoor; EVA.
Order number **NTV-3503-F02L-P | F.01U.396.874**

NTV-3503-F03L-P Turret camera 5MP HDR 100° IK08 IR
IP turret camera with tamper and motion detection; 5MP 1080p resolution; 100° lens; with built-in IR illuminator; indoor; EVA.
Order number **NTV-3503-F03L-P | F.01U.396.875**

Accessories

NPD-5001-POE Midspan, 15W, single port, AC in
Power-over-Ethernet midspan injector for use with PoE enabled cameras; 15.4 W, 1-port
Weight: 200 g (0.44 lb)
Order number **NPD-5001-POE | F.01U.305.288**

NPD-5004-POE Midspan, 4 port x 15W, AC in
Power-over-Ethernet midspan injector for use with PoE enabled cameras; 15.4 W, 4-ports
Weight: 620 g (1.4 lb)
Order number **NPD-5004-POE | F.01U.305.289**

UPA-1220-50 Power supply, 220VAC 50Hz, 12VDC 1A out
Power supply for camera. 110-240 VAC, 50/60 Hz In; 12 VDC, 1 A Out; regulated.
Input connector: 2-prong, European Europlug standard (4 mm / 19 mm).
Order number **UPA-1220-50 | F.01U.076.158**

UPA-1220-60 Power supply, 120VAC 60Hz, 12VDC 1A out
Power supply for camera. 100-240 VAC, 50/60 Hz In; 12 VDC, 1 A Out; regulated.
Input connector: 2-prong, North American standard (non-polarized).
Order number **UPA-1220-60 | F.01U.076.155**

Services

EWE-3000II -IW 12 mths wrty ext 3000i series indoor
12 months warranty extension
Order number **EWE-3000II -IW | F.01U.382.248**

Represented by:

Europe, Middle East, Africa:
Bosch Security Systems B.V.
P.O. Box 80002
5600 JB Eindhoven, The Netherlands
Phone: +31 40 2577 284
emea.securitysystems@bosch.com
emea.boschsecurity.com

Germany:
Bosch Sicherheitssysteme GmbH
Robert-Bosch-Ring 5
85630 Grasbrunn
Germany
www.boschsecurity.com

North America:
Bosch Security Systems, LLC
130 Perinton Parkway
Fairport, New York, 14450, USA
Phone: +1 800 289 0096
Fax: +1 585 223 9180
onlinehelp@us.bosch.com
www.boschsecurity.us

Asia-Pacific:
Robert Bosch (SEA) Pte Ltd, Security Systems
11 Bishan Street 21
Singapore 573943
Phone: +65 6571 2808
Fax: +65 6571 2699
apr.securitysystems@bosch.com
www.boschsecurity.asia