

Standard Dome Accessories

Accessories for Indoor/Outdoor Ceiling, Wall, Pole and Corner Mounting Solutions



Ceiling Mount Configuration

Wall Mount Configuration with Pole Mount Adapter

Wall Mount Configuration

Wall Mount Configuration with Corner Mount Adapter

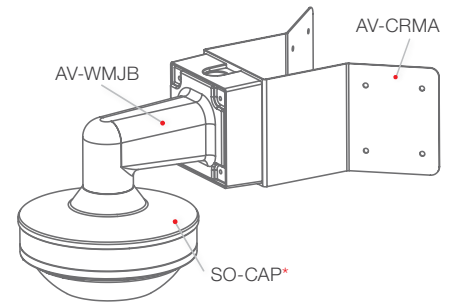
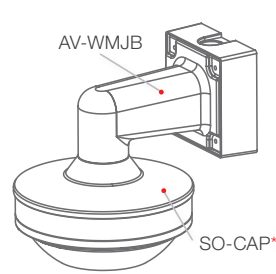
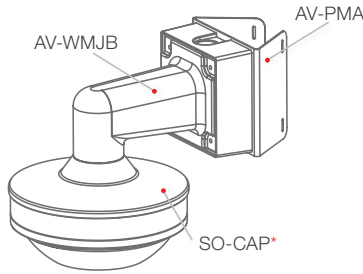
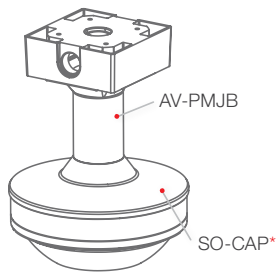

Cap Options:

SO-CAP

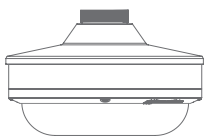

Works with SurroundVideo[®] Omni and SurroundVideo[®] Omni G2

SV-CAP

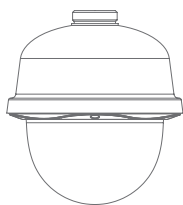

Works with SurroundVideo[®] and SurroundVideo[®] G5

MD-CAP

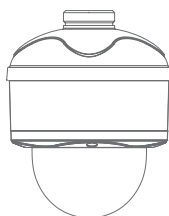

Works with MegaDome[®] 4K, MegaDome[®] Series, SurroundVideo[®] G5 Mini and MegaVideo[®] Compact D4SO

Compatible Cameras:



SurroundVideo[®] Series



MegaDome[®] 4K



MegaDome[®] Series



MegaVideo[®] Compact D4SO

*Can be switched with SV-CAP or MD-CAP

AV-EBAR

Electrical Box Adapter Round



Features:

- Easy Installation and Superior Design
- Heavy Duty Enclosure Protection for Applications in Harsh Environments
- Die-Cast Aluminum is Resistant to Impact and Salt Damage

Compatibility	Compatible with 3/4" NPT standard
	Works with MegaBall® Series, MegaDome® Series, MicroDome® Series -S cameras, SurroundVideo® Series, SurroundVideo Omni Series, MegaVideo® D4SO Housing, and MB2-JBA

Mechanical	Casing Material	Aluminum
	Color	Ivory (Pantone Cool Gray 1C)
	Dimensions	Ø6" (152.4mm) x 0.15" W (4mm)
	Weight	w/o Camera 0.4lbs (0.18kg)

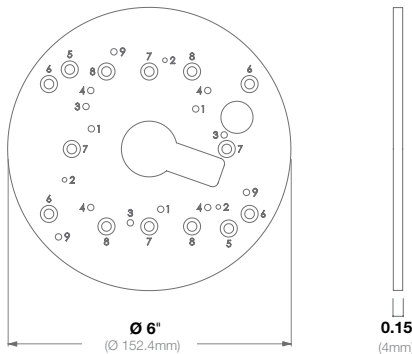

Hole No.	Model Compatibility
1	MegaBall Series Wall Mount (legacy)
2	MegaBall Series Dome Mount
3	MegaBall Series Bell Mount, MicroDome Series Surface Mount*
4	MegaDome 2*, SurroundVideo Series Panoramics*, MegaVideo D4SO Housing, MB2-JBA
5	4S Box
6	4-11/16" Square Box
7	Single Gang Box
8	Double Gang Box
9	SurroundVideo Omni Series

* The mounting plate on MegaDome 4K, SurroundVideo G5 Mini, and MicroDome Duo negate the need for a separate electrical box adapter and therefore this accessory is not applicable.

Quick Installation:

1. Pass cables through the center hole of the adapter plate.
2. Attach the adapter plate to the electrical box (sold separately) using the appropriate hardware and mounting holes.
3. Attach the compatible part noted above.

AV-EBAS

Electrical Box Adapter Square



Features:

- Easy Installation and Superior Design
- Heavy Duty Enclosure Protection for Applications in Harsh Environments
- Die-Cast Aluminum is Resistant to Impact and Salt Damage

Compatibility	Compatible with 3/4" NPT standard
	Works with MegaDome® Series, MegaView® Series, MicroBullet™, SurroundVideo® Panoramic Series, MegaVideo® D4SO Housing, AV-JBA, AV-WMJJB, AV-SWMJJB, MCD-WMT, MDD-WMT, HSG2-WMT, and AV-PMJJB

Mechanical	Casing Material	Aluminum
	Color	Ivory (Pantone Cool Gray 1C)
	Dimensions	4.7" L (120mm) x 0.15" W (4mm) x 4.7" H (120mm)
	Weight	w/o Camera 0.33lbs (0.13kg)

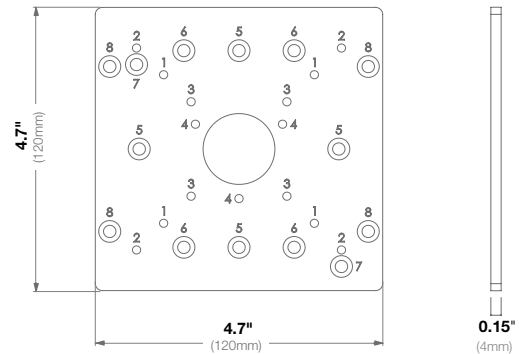

Hole No.	Model Compatibility
1	AV-JBA, AV-WMJJB, AV-PMJJB, MegaDome 2*, MegaView 2 (standard), SurroundVideo Panoramics*, MegaVideo D4SO Housing
2	HSG2-WMT, AV-WMJJB bracket, AV-PMJJB bracket, MegaView 2 bracket
3	AV-SWMJJB, MCD-WMT, MDD-WMT
4	MicroBullet
5	Single Gang Box
6	Double Gang Box
7	4S Box
8	4-11/16" Square Box

* The mounting plate on MegaDome 4K and SurroundVideo G5 Mini negate the need for a separate electrical box adapter and therefore this accessory is not applicable.

Quick Installation:

1. Pass cables through the center hole of the adapter plate.
2. Attach the adapter plate to the electrical box (sold separately) using the appropriate hardware and mounting holes.
3. Attach the compatible part noted above.



AV-PMJB

Pendant Mount Bracket with Junction Box



Features:

- Easy Installation and Superior Design
- Heavy Duty Enclosure Protection for Applications in Harsh Environments
- Die-Cast Aluminum is Resistant to Impact and Salt Damage

Compatibility	Compatible with 1.5" NPT Female
	Works with SurroundVideo® Series, MegaDome® 4K, MegaDome® Series, and MegaVideo® Compact D4SO

Mechanical	Casing Material	Aluminum
	Color	Ivory (Pantone® Cool Gray 1C)
	Dimensions	5.87" H (149.31mm) x 4.69" W (119.20mm)
	Weight	w/o Camera 2.12lbs (0.96kg)

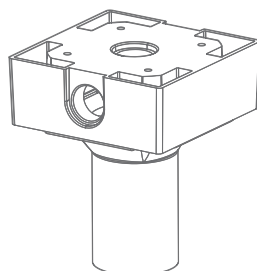
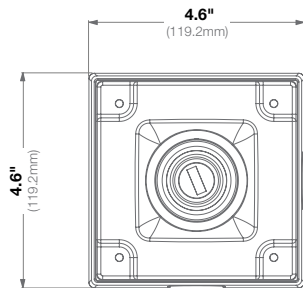
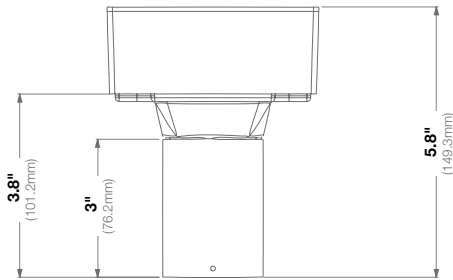

AV-WMJB

Wall Mount Bracket with Junction Box



Features:

- Easy Installation and Superior Design
- Heavy Duty Enclosure Protection for Applications in Harsh Environments
- Die-Cast Aluminum is Resistant to Impact and Salt Damage

Compatibility	Compatible with 1.5" NPT Female
	Works with SurroundVideo® Series, MegaDome® 4K, MegaDome® Series, and MegaVideo® Compact D4SO

Mechanical	Casing Material	Aluminum
	Color	Ivory (Pantone® Cool Gray 1C)
	Dimensions	7.68" L (195.05mm) x 4.69" W (119.20mm)
	Weight	w/o Camera 2.49lbs (1.13kg)

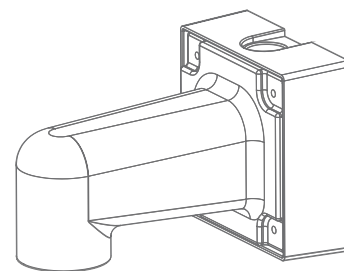
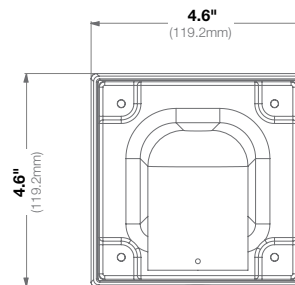
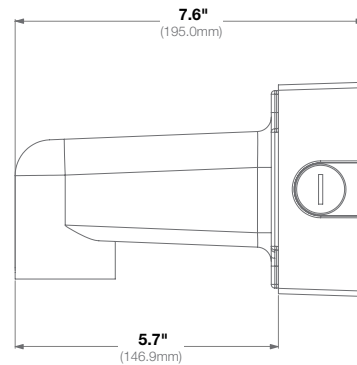

AV-PMA

Pole Mount Adapter



Features:

- Easy Installation and Superior Design
- Heavy Duty Enclosure Protection for Applications in Harsh Environments
- Die-Cast Aluminum is Resistant to Impact and Salt Damage

Compatibility Works with AV-WMJB, AV-SWMJB, MDD-WMT, MCD-WMT, and AV-JBA

Mechanical	Casing Material	Aluminum
	Color	Ivory (Pantone® Cool Gray 1C)
	Dimensions	5.01" W (127.32mm) x 4.92" H (125mm)
	Weight	w/o Camera 0.32lbs (0.15kg)

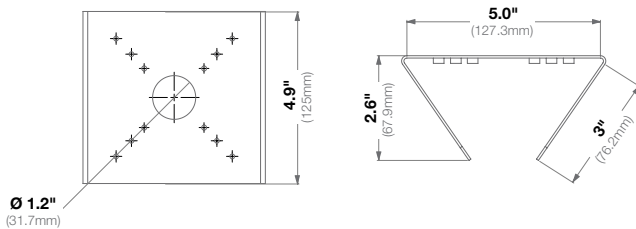

AV-CRMA

Corner Mount Adapter

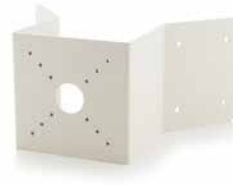

Features:

- Easy Installation and Superior Design
- Heavy Duty Enclosure Protection for Applications in Harsh Environments
- Die-Cast Aluminum is Resistant to Impact and Salt Damage

Compatibility Works with AV-WMJB, AV-SWMJB, MDD-WMT, MCD-WMT, and AV-JBA

Mechanical	Casing Material	Aluminum
	Color	Ivory (Pantone® Cool Gray 1C)
	Dimensions	13.04" W (331.25mm) x 4.92" H (125mm)
	Weight	w/o Camera 0.59lbs (0.27kg)

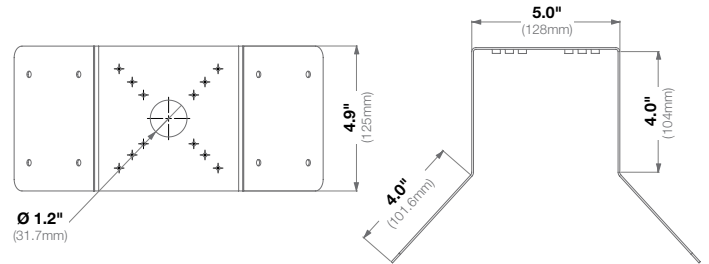

SO-CAP

Mounting Cap



Features:

- Easy Installation and Superior Design
- Heavy Duty Enclosure Protection for Applications in Harsh Environments
- Die-Cast Aluminum is Resistant to Impact and Salt Damage

Compatibility Compatible with 1.5" NPT Male
Works with SurroundVideo® Omni and SurroundVideo® Omni G2

Mechanical	Casing Material	Aluminum
	Color	Ivory (Pantone® Cool Gray 1C)
	Dimensions	Ø 7.87" (200mm) x 1.6" H (40.79mm)
	Weight	w/o Camera 0.85lbs (0.39kg)

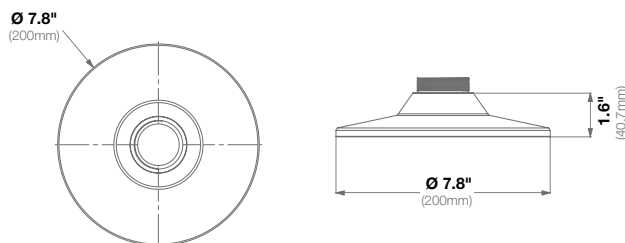

SV-CAP

Mounting Cap



Features:

- Easy Installation and Superior Design
- Heavy Duty Enclosure Protection for Applications in Harsh Environments
- Die-Cast Aluminum is Resistant to Impact and Salt Damage

Compatibility Compatible with 1.5" NPT standard
Works with SurroundVideo® and SurroundVideo® G5

Mechanical	Casing Material	Aluminum
		IP66 Outdoor Protection Grade
	Color	Ivory (Pantone® Cool Gray 1C)
	Dimensions	Ø 7.4" (189mm) x 4.33" H (110mm)
	Weight	w/o Camera 1.47lbs (0.69kg)

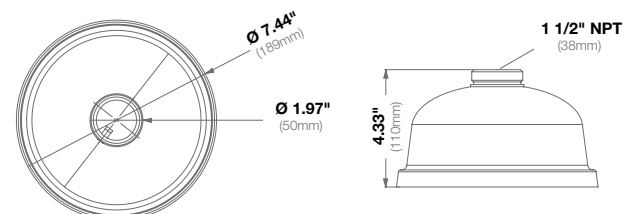

MD-CAP

Mounting Cap



Features:

- Easy Installation and Superior Design
- Heavy Duty Enclosure Protection for Applications in Harsh Environments
- Die-Cast Aluminum is Resistant to Impact and Salt Damage

Compatibility	Compatible with 1.5" NPT standard	
	Works with MegaDome® 4K, MegaDome® Series, SurroundVideo® G5 Mini and MegaVideo® Compact D4SO	

Mechanical	Casing Material	Aluminum	
	Color	Ivory (Pantone® Cool Gray 1C)	
	Dimensions	Ø 6.06" (154.1mm) x 2.57" H (65.3mm)	
	Weight	w/o Camera	1.02lbs (0.465kg)

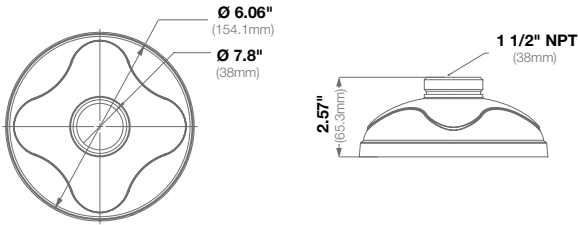

SV-FMA

Flush Mount Adapter



Features:

- Easy Installation and Superior Design
- Low Profile Installation

Compatibility	Works with SurroundVideo®	
----------------------	---------------------------	--

Mechanical	Casing Material	Aluminum and Plastic	
	Color	Ivory (Pantone® Cool Gray 1C)	
	Dimensions	Ø 8.54" (217mm) x 2.92" H (74.2mm)	
	Weight	w/o Camera	1.3lbs (0.59kg)

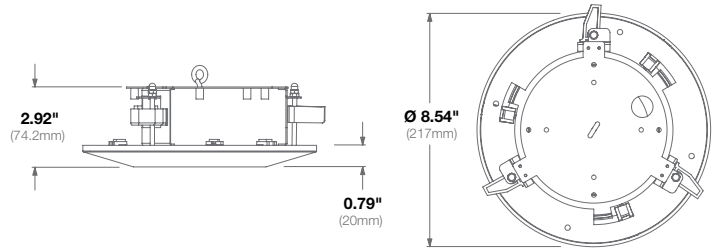

SO-FMA

Flush Mount Adapter



Features:

- Easy Installation and Superior Design
- Low Profile Installation

Compatibility	Works with SurroundVideo® Omni and SurroundVideo® Omni G2	
----------------------	---	--

Mechanical	Casing Material	Aluminum and Plastic	
	Color	Ivory (Pantone® Cool Gray 1C)	
	Dimensions	Ø 9.46" (240.3mm) x 2.67" H (67.9mm)	
	Weight	w/o Camera	1.15lbs (0.52kg)

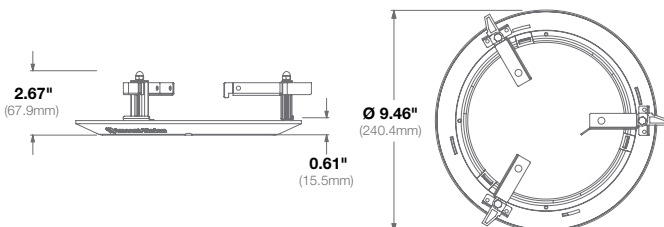

AV-FMA

Flush Mount Adapter



Features:

- Easy Installation and Superior Design
- Low Profile Installation

Compatibility	Works with MegaDome® 4K, MegaDome® Series, SurroundVideo® G5 Mini and MegaVideo® Compact D4SO	
----------------------	---	--

Mechanical	Casing Material	Aluminum and Plastic	
	Color	Ivory (Pantone® Cool Gray 1C)	
	Dimensions	Ø 8.54" (217mm) x 3.9" H (99.1mm)	
	Weight	w/o Camera	1.10lb (0.5kg)

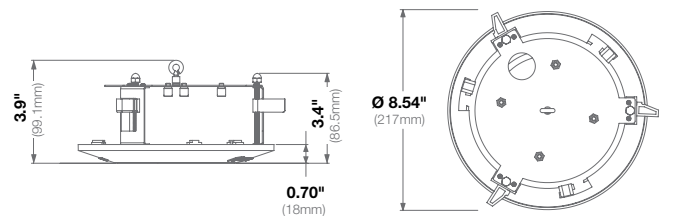

AV-JBA

Square Junction Box Adapter



Features:

- Easy Installation and Superior Design
- Heavy Duty Enclosure Protection for Applications in Harsh Environments
- Die-Cast Aluminum is Resistant to Impact and Salt Damage

Compatibility	Compatible with 3/4" NPT standard
	Works with AV-PMJB*, AV-WMJB*, D4S-WMT, HSG2-WMT, and MegaView® 2*

Mechanical	Casing Material	Aluminum
		IP66 Outdoor Protection Grade
	Color	Ivory (Pantone® Cool Gray 1C)
	Dimensions	4.7" L (120mm) x 4.7" W (120mm) x 1.89" H (48.1mm)
	Weight	w/o Camera 1.3lbs (0.63kg)

* Replacement part for these models

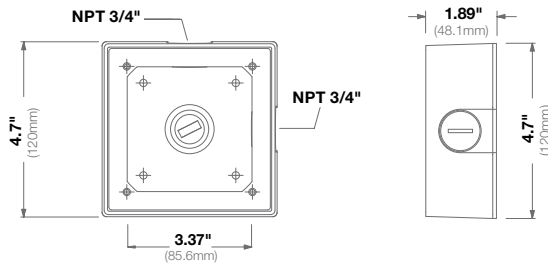

MD-JBA

Round Junction Box Adapter



Features:

- Easy Installation and Superior Design
- Heavy Duty Enclosure Protection for Applications in Harsh Environments
- Die-Cast Aluminum is Resistant to Impact and Salt Damage

Compatibility	Compatible with 3/4" NPT standard
	Works with MegaDome® 4K, MegaDome® Series, SurroundVideo® G5 Mini and MegaVideo® Compact D4SO

Mechanical	Casing Material	Aluminum
	Color	Ivory (Pantone® Cool Gray 1C)
	Dimensions	Ø 6.06" (154mm) x 1.5" H (40mm)
	Weight	w/o Camera 1lbs (0.45kg)

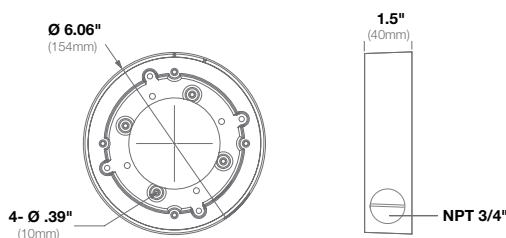

SO-SAA

Sun Shield Accessory



Features:

- Easy Installation and Superior Design
- Protects SurroundVideo Omni Series Sensors from Sun Glare

Compatibility	Works with SurroundVideo® Omni Series Cameras
----------------------	---

Mechanical	Casing Material	Plastic
	Color	Ivory (Pantone® Cool Gray 1C)
	Dimensions	11.03" L (280.22mm) x 0.79" H (20.25mm)
	Weight	w/o Camera 0.17lb (0.08kg)

