

MK Series DOOR SENTRY VIDEO ENTRY SECURITY INTERCOM

Models: **MK-1MD** *Main audio/monitor station*
MK-1MD/A

INSTALLATION & OPERATION MANUAL

Before actually installing MK-1MD(/A), the contents of this Manual must be thoroughly read and understood.

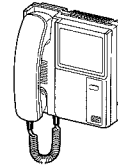



PRECAUTIONS ON INSTALLATION & WIRING

 : **WARNING**
(Negligence could result in death or serious injury to people)

 : **GENERAL PRECAUTIONS**

 : General prohibitions.

 : Prohibitions to subject the unit to water.







 : **CAUTION**
(Negligence could result in injury to people or damage to property)

 : Prohibitions to dismantle the unit.

 : Take the unit to earth ground



WARNING

1. Do not change or modify MK-1MD(/A) equipment. 
2. Do not connect any power source other than specified to terminals +, - on MK-1MD(/A). Doing so can cause fire or damage the unit. 
3. The MK-1MD(/A) equipment must not be exposed to water or any other liquid. 
4. Do not open MK-1MD(/A) monitor unit. The high voltage is inside. 
5. Make sure wires are connected properly before plugging in the power supply. 
6. Keep AC outlet away from moisture and dust.
7. Do not put any forcible strength on the monitor of MK-1MD(/A). It can cause injury. 



CAUTION

1. Do not install or make any wire terminations while power supply is turned on. It can cause electrical shock or damage the unit.
2. Mount the MK-1MD(/A) monitor on wall in a convenient location, but not where it could be bumped or jarred.

3. Do not install MK-1MD(/A) components in any of the following locations, as it may cause the system to malfunction;

- High or extreme cold temperature area: under direct sunlight, near equipment that varies in temperature, in front of air-conditioner, inside a refrigerated area, etc.
- Places subject to moisture or humidity extremes.
- Places subject to environmental conditions, such as oil, dust, chemicals, salt, etc. 
- Places subject to constant vibration or impact.



GENERAL PRECAUTIONS

1. MK-1MD(/A) equipment, except for MK-DS(/A), is designed for indoor use only. Do not install outdoors.
2. MK-1MD(/A) system is not operable during a power failure.
3. In areas where broadcasting station antennas are close by, intercom system may be affected by radio frequency interference.
4. Keep all DC wiring at least 30cm, 20" away from AC 100 ~ 240V wiring, fluorescent lighting, or dimmer switches. Otherwise, cross AC wiring at a 90° angle.



SYSTEM OUTLINE & COMPONENTS

MKS-1E DOOR SENTRY is a set with one monitor and one video door station for audio and video door answering and door release.

A second monitor or audio-only handset can be added.

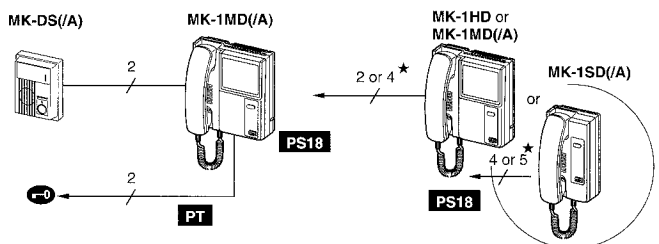

★ Additional wire(s) for door release.

Package contents

- **MKS-1E**, AC 120V (USA) or AC 220-240V
Boxed set with Main monitor MK-1MD(/A), Door station MK-DS(/A) & Power supply (PS-18YC/A or PS-18YE)
- Mounting bracket
- Packet of screws
- Installation & Operation Manual





Components available

• Video door station • Monitor & audio stations

• Call extension

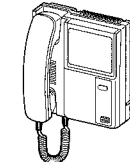
• Door strike

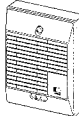
• Power supply

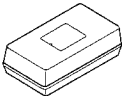
<p>MK-DS(/A)</p>  <p>Surface mount</p>	<p>MK-1MD(/A) main or sub MK-1HD sub</p>  <p>Audio/monitor station</p>	<p>MK-1SD(/A)</p>  <p>Sub audio-only station</p>	<p>IER-2</p>  <p>Chime extension</p>	<p>EL-9S</p>  <p>AC 12V, 0.35A</p>	<p>PS-18YC/A AC 120V, 50/60Hz or PS-18YE AC 220-240V, 50/60Hz.</p> 
--	---	--	--	--	--

★Second room station: Either MK-1MD(/A), MK-1HD or MK-1SD(/A).

2 NAMES AND FEATURES

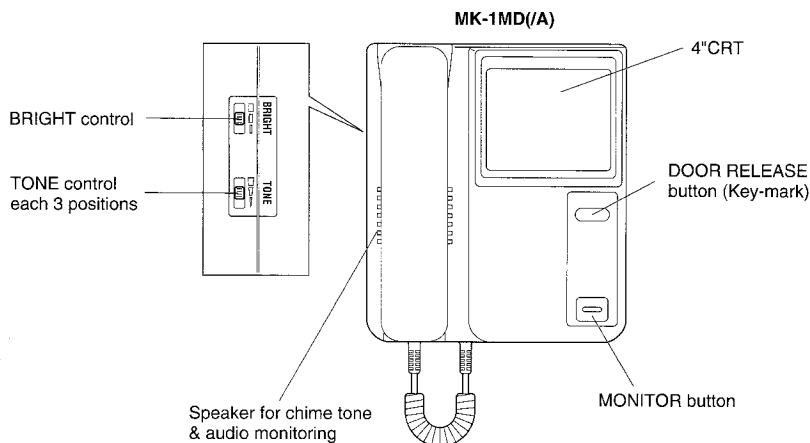

Features

- ☆ One door and one monitor system, expandable with second audio/monitor or audio-only sub station.
- ☆ Wide angle door station: Views 70cm vertically and 100cm horizontally (70°V x 90°H).
- ☆ Camera angle adjuster on MK-DS(/A) (Turns up camera angle by 14°).

3 WIRING

■ Cable requirements

- Use a parallel conductor cable. Coaxial cable should not be used.
- When existing chime wires are used, it is possible that the wires may contain AC voltage current. Locate and remove the bell transformer before actually connecting MK-DS(/A).
- Extra pair(s) in the installed cable can affect image quality, and must be terminated with a 120 ohm resistor at each end at both MK-DS(/A) and MK-1MD(/A). Otherwise, double up the wires onto each terminal.

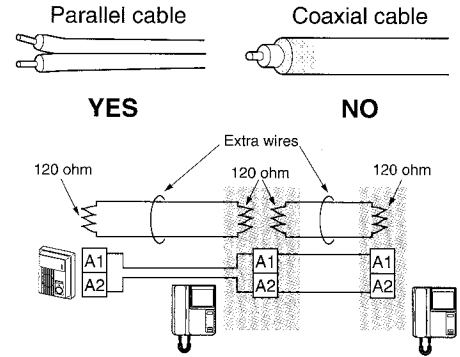

■ Installation location

MK-DS(/A)

MK-DS(/A) employs CCD camera and the performance can be affected by bright direct light, such as strong sunlight, gate light, or street or porch light which comes directly into the camera lens.

MK-1MD(/A)

Mount the video monitor so that the center of the monitor screen comes to the eye level of the user.

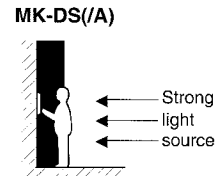

MK-1MD(/A)



■ When camera height is too low

MK-DS(/A) is equipped with a camera-angle adjuster on the back of the unit. Pull the lever down to adjust the camera angle upward by 14°.

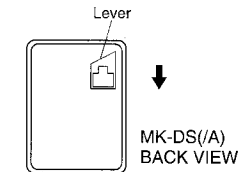

• When camera is positioned horizontally;

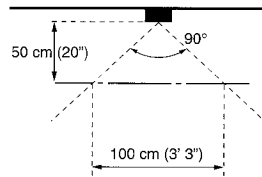
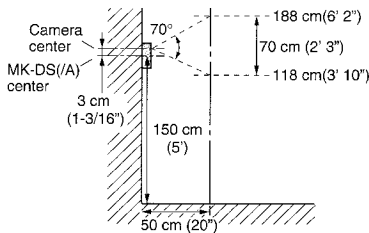

• When camera angle is upwardly adjusted;

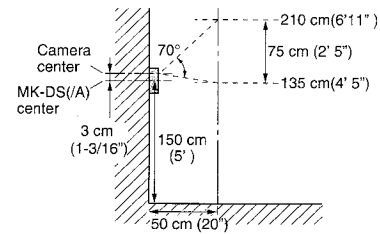

■ When installing a second station

MK-1MD(/A) may have a sub station, either the same MK-1MD(/A) monitor or MK-1SD(/A) handset. Locate the second station within permitted distance of 100m, 330' from the camera. Wire second inside station directly to first inside station.

- **Video-impedance matching (on SW1):** In dual monitor system only, change initial A setting to B (HIGH) position on MK-1MD(/A) main-monitor.

■ Call extension

To hear the chime in a remote location, install an IER-2 speaker with 2 wires(NP) from any inside station. One IER-2 per station.

■ Door strike

MK-1MD(/A) monitor provides a dry closure contact for door strike. Use Aiphone's EL-9S, AC 12V, 0.35A, powered by AC transformer PT-1210N in USA, or a strike appropriate for the door.

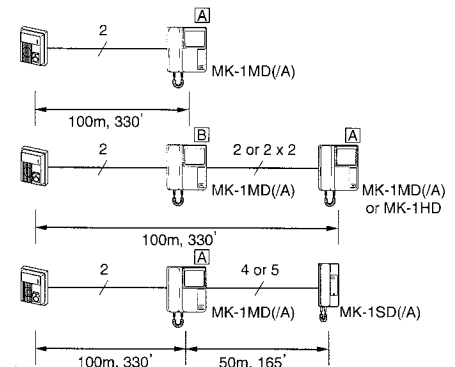

Wiring diagrams

Single MK-1MD(/A) system

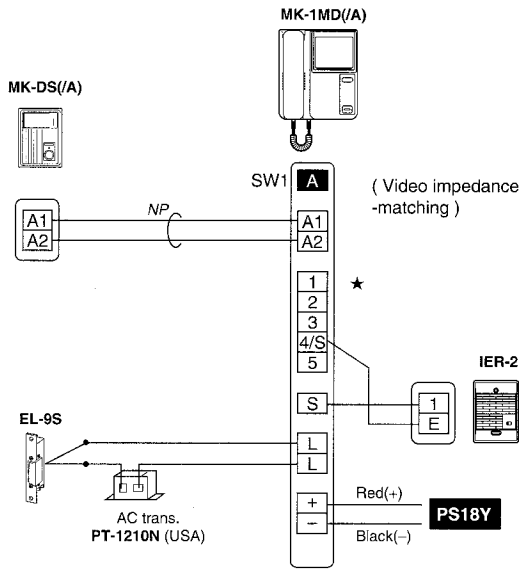

★ Terminals 1-5 are for MK-1SD(/A) audio station.

NP: Non-polarized P: Polarized. : Parallel cable

PS18Y: PS-18YC/A or PS-18YE (specified)

Do not run door release & audio/video wires in the same jacketed cable.

Two-monitor system

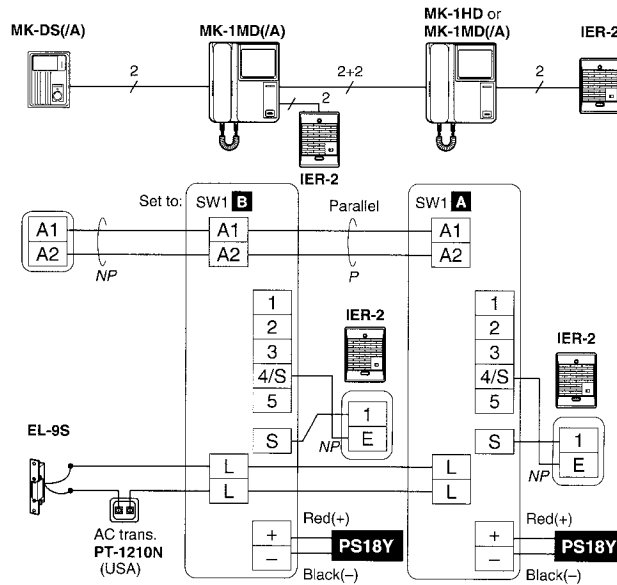

Video-impedance matching

The SW1, initially set to A position, must not be changed except to B position on the first MK-1MD(/A) station of 2-monitor system.

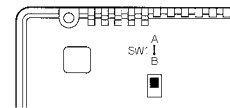

MK-1MD(/A) or MK-1HD
Back View

4 MOUNTING

MK-1MD(/A)

On back of the unit, mounting bracket is attached.

1. Mount the bracket to single-gang box or wall.
2. On the back, terminate parallel wires on A1, A2 terminals.
3. Connect 18V DC output wires from PS-18Y power supply. Red to (+), Black to (-).
4. Mount MK-1MD(/A) monitor onto the bracket, aligning at marks.
Pull down until it firmly locks.
5. Plug PS-18Y into an open AC outlet.

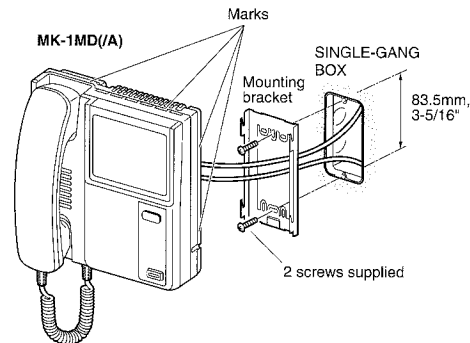

PS-18YC/A (AC 120V), PS-18YE (AC 220-240V)

Install the power supply within 1.9m, 6'3" of the monitor.
Do not attempt to extend the DC side of the power supply. If necessary, extend the AC side with an extension cord.

PS-18YC/A
or **PS-18YE**

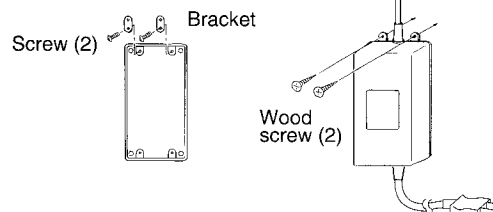

5 OPERATIONS on MK-1MD(/A)

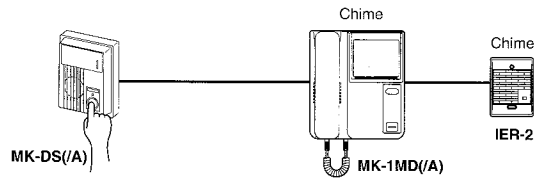
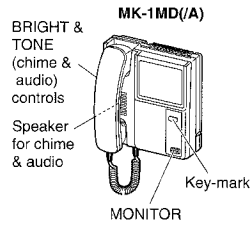

■ Receiving a door call:

When call button is pushed on MK-DS(/A), it activates 4-tone chime and image at inside monitor(s). Simply lift handset to reply within 30 seconds.

■ Communication:

The communication is timed for 2-1/2 minutes. Press MONITOR button to extend another 2-1/2 minutes.

★ Monitor image times out in 30 seconds after called.

■ Audio / visual monitoring:

In standby mode, press MONITOR button to activate both audio & video of door station. Audio is heard through open voice speaker.

■ Call extension speaker

IER-2 allows the chime to be heard at a remote location. Volume is adjustable to 3 positions.

■ Controls

On MK-1MD(/A):
 MONITOR (on front).
 BRIGHT & TONE, chime & audio volume, each 3 positions (on left side).

■ Second Audio/monitor or Audio-only station

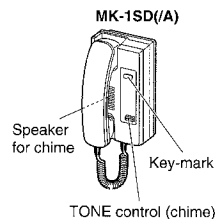
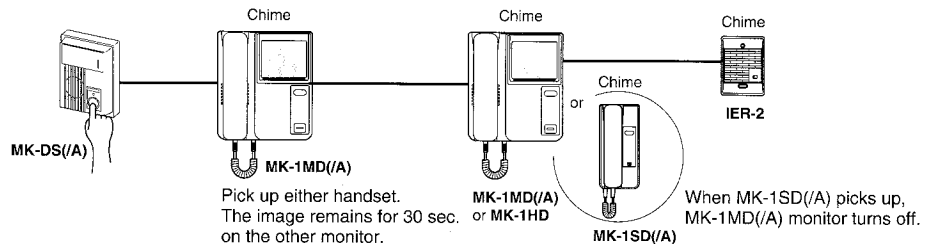

The second monitor operates exactly the same as main monitor. MK-1SD(/A) can be used for door answering and door strike. There is no calling between the inside stations.

★ If someone at hearing the other station is answering the door, hang up handset.

6 TECHNICAL PRECAUTIONS

- **Temperature:** MK-1MD(/A) is rated to operate between temperatures 0°C ~ 40°C (+32°F ~ +104°F).
- It takes approx. one second for system to recycle.
- Image may vary when the Key-mark button is held down to activate door strike. This is not a malfunction.
- MK-1MD(/A) monitor can work with MY Series door components:
MY-DS, MYW-CA (w/MY-CA inside) and **MYW-BA** long-distance adaptor.
- Image through overhead MYW-CA may vary, but it is not a malfunction.
- Do not operate MONITOR button and plug in at the same time. It will create a continuous high-pitched tone, and can be reset by momentarily unplugging power supply.
- **Cleaning:** Clean MK-1MD(/A) with a soft cloth dampened with neutral household cleanser. Do not use any abrasive cleaner or cloth.

7 SPECIFICATIONS

- Power source: MK-1MD(/A): DC 18V, 0.8A, 0.04A (standby).
- Power supply: PS-18YC/A, AC 120V, 50/60Hz.
 PS-18YE, AC 220-240V, 50/60Hz.,
 each with secondary output: DC 18V, 1.2A.
- Image viewing area:
When camera is in horizontal position;
When camera is upwardly adjusted;
 70cm V x 100cm H (2'3" V x 3'3" H)
 75cmV x 100cmH (2'5" V x 3'3" H)
- Communication:
 Call-in: Image is on 30 sec.
 Communication: 2-1/2 min. timed.
 Extend with MONITOR button.
 Common talk between rooms (hang up either handset)
- MK-DS(/A) camera unit: CCD camera with infrared LEDs.
- MK-1MD(/A) monitor: 4 inch direct view flat CRT
- Scanning lines: 525 lines.
- Minimum illumination: Less than 1 Lux at 50cm, 20" distance.
- Door release contact capacity: AC 12V, 0.4A (dry closure contact EL, EL).
- Wiring: 2 wires parallel, non-polarized (Aiphone #841802 in USA).
- Wiring distance: MK-1MD(/A) to MK-DS(/A);

0.65mm φ	1.0mm φ	22AWG	18AWG
50m	100m	165'	330'

- Dimensions & weight:

Models	H	W	D (mm)	Weight (approx.)
MK-DS(/A)	130	98	37.5	230g
MK-1MD(/A) or 1HD 210		186	78	1,130g
MK-1SD(/A)	210	100	74	415g

H	W	D	Weight (approx.)
5-1/8"	3-7/8"	1-1/2"	0.51 lbs.
8-1/4"	7-5/16"	3-1/16"	2.49 lbs.
8-1/4"	4"	3"	0.91 lbs.

This equipment has been tested and found to comply with the limits for a Class B digital device, pursuant to Part 15 of the FCC Rules. These limits are designed to provide reasonable protection against harmful interference in a residential installation. This equipment generates, uses, and can radiate radio frequency energy and, if not installed and used in accordance with the instructions, may cause harmful interference to radio communications. However, there is no guarantee that interference will not occur in a particular installation. If this equipment does cause harmful interference to radio or television reception, which can be determined by turning the equipment off and on, the user is encouraged to try to correct the interference by one or more of the following measures:

- Reorient or relocate the receiving antenna.
- Connect the equipment into an outlet on a circuit different from that to which the receiver is connected
- Increase the separation between the equipment and receiver.
- Consult the dealer or an experienced radio/TV technician for help.

WARRANTY

Aiphone warrants its products to be free from defects of material and workmanship under normal use and service for a period of two years after delivery to the ultimate user and will repair free of charge or replace at no charge, should it become defective upon which examination shall disclose to be defective and under warranty. Aiphone reserves unto itself the sole right to make the final decision whether there is a defect in materials and/or workmanship; and whether or not the product is within the warranty.

This warranty shall not apply to any Aiphone product which has been subject to misuse, neglect, accident, or to use in violation of instructions furnished, nor extended to units which have been repaired or altered outside of the factory. This warranty does not cover batteries or damage caused by batteries used in connection with the product.

This warranty covers bench repairs only, and any repairs must be made at the shop or place designated in writing by Aiphone.

Aiphone will not be responsible for any costs incurred involving on site service calls.

Aiphone Co., Ltd., Nagoya, Japan
 Aiphone Corporation, Bellevue, WA, USA

